

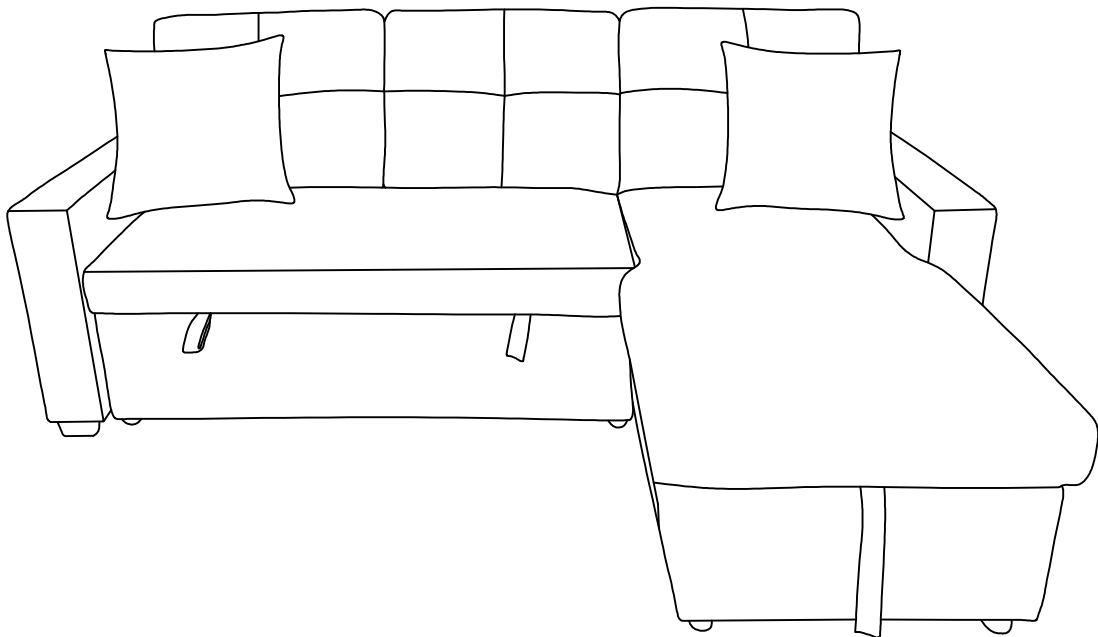

Assembly Instructions



ITEM NO.: 81412

**IMPORTANT: PLACE ALL PARTS ON A CLEAN AND SMOOTH SURFACE SUCH AS A RUG OR CARPETTO
AVOID THE PARTS FROM BEING SCRATCHED
KINDLY FOLLOW THE ADDEMBLY
INSTRUCTIONS SREP
DO NOT TIGHTEN ALL SCREWS UNTIL THE BED
IS FULLY SET-UP**



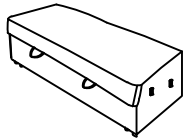
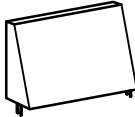
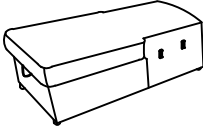

ASSEMBLY INSTRUCTIONS

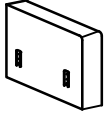
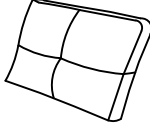
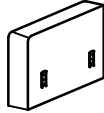



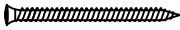
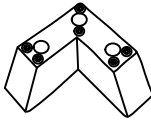
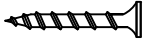



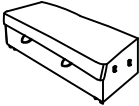

PARTS LIST

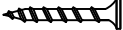
PART	DRAWING	DESCRIPTION	QTY	PART	DRAWING	DESCRIPTION	QTY
F		Love Seat	1	K		Backrest	3
G		Chaise	1	L		Pillow	2
H		Right Arm	1	M		Cushion	3
I		Left Arm	1				

HARDWARE LIST

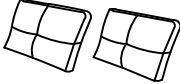
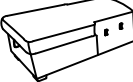
PART	DRAWING	DESCRIPTION	QTY	PART	DRAWING	DESCRIPTION	QTY
A		Screw #10 x 50mm	20	D		Legs	4
B		Screw #8 x 25mm	16	E		Roller	4
C		Legs	8				

81412 is packed in 3 cases

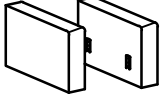
Carton	Disignation	Part	Hardware
81412-1	Love seat	#F 	 #Ax20pcs  #Bx16pcs  #Cx8pcs  #Dx4pcs  #Ex4pcs
	Cushion	#M 	
81412-2	Chaise	#G 	
	Backrest	#K 	
	Pillow	#L 	
	Cushion	#M 	
81412-3	L-R Arm		

ASSEMBLY INSTRUCTIONS

THE PARTS ARE LOCATED INSIDE THE BOX AS BELOW:

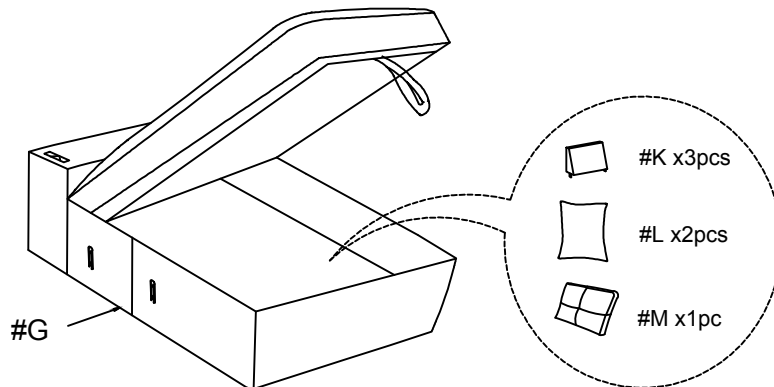
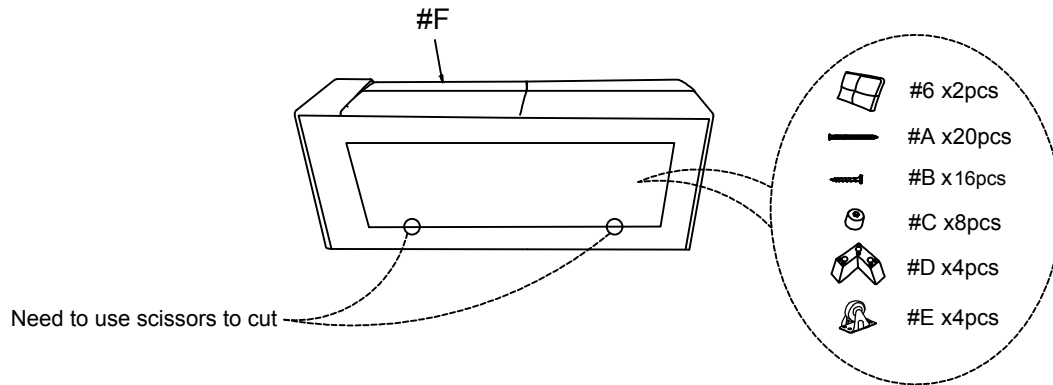

STEP 1

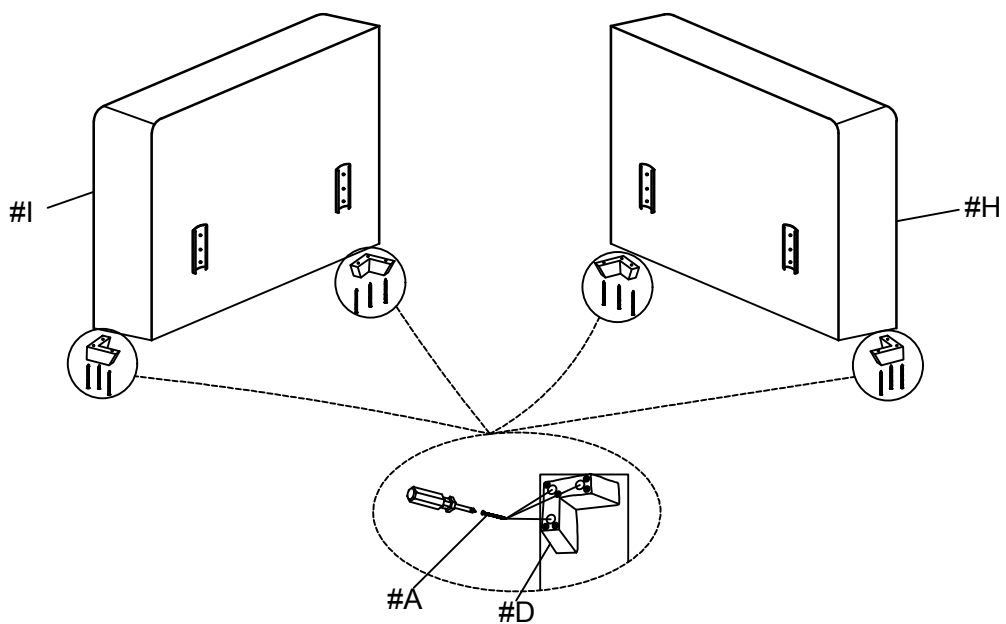

ASSEMBLY INSTRUCTIONS

STEP 2

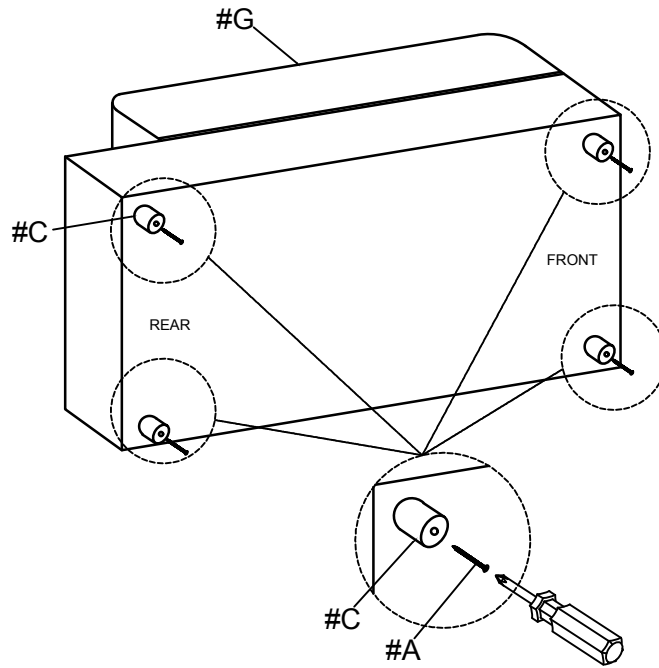

STEP 3

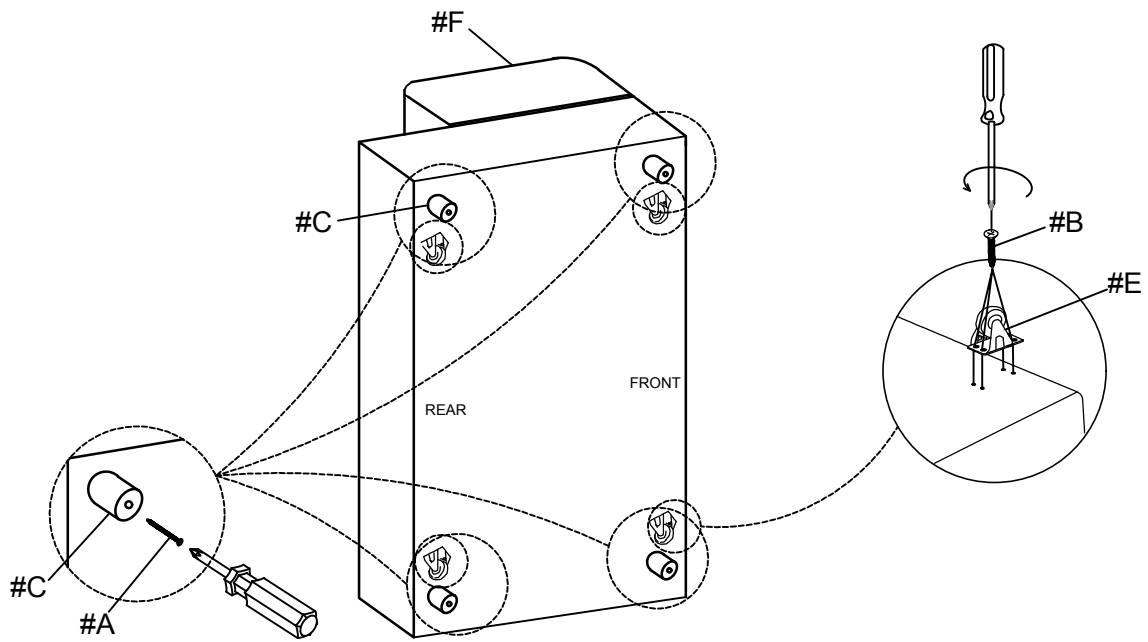

ASSEMBLY INSTRUCTIONS

STEP 4

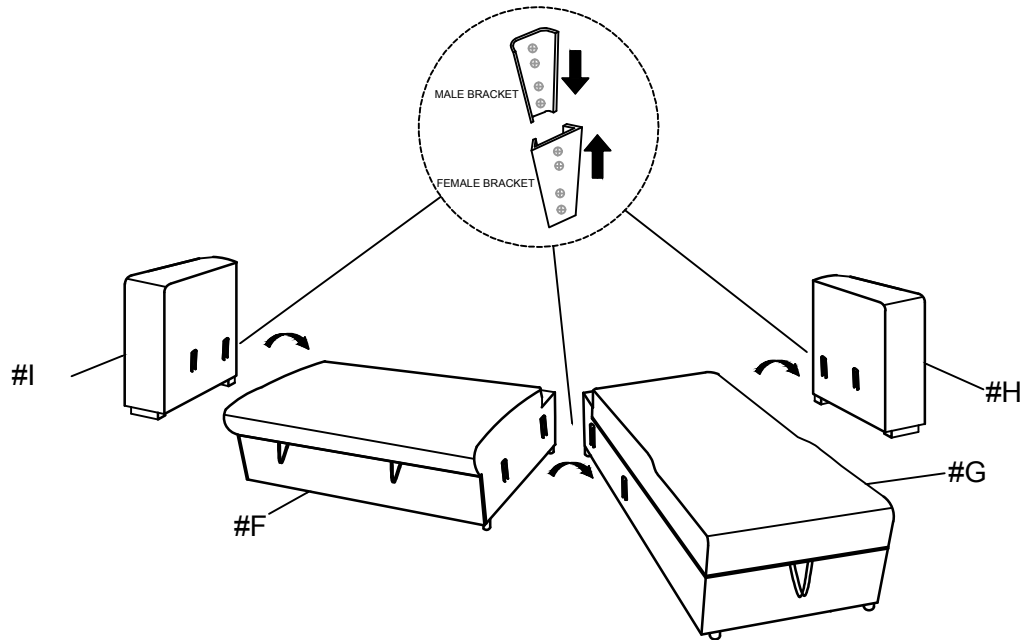

STEP 5

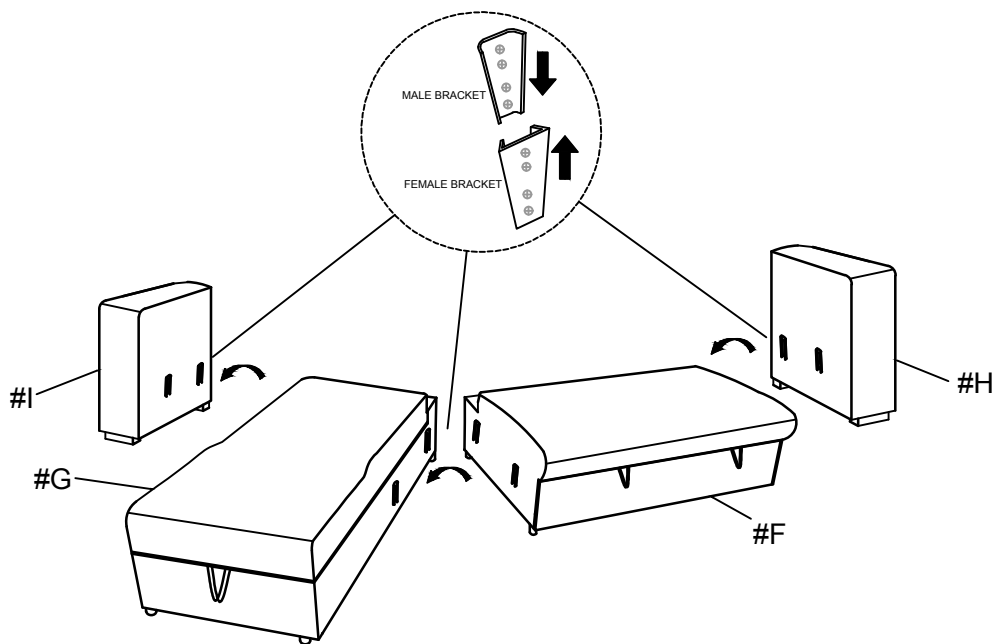

ASSEMBLY INSTRUCTIONS

STEP 6

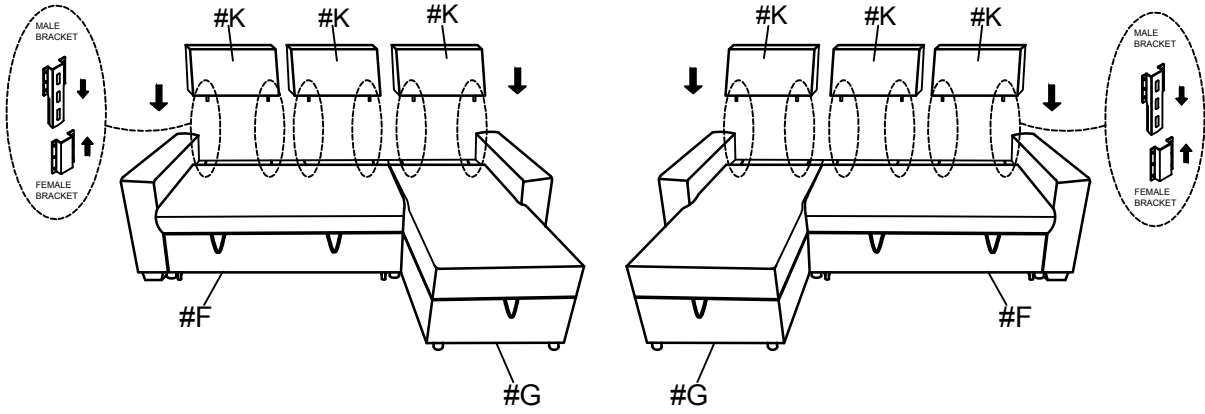

STEP 7

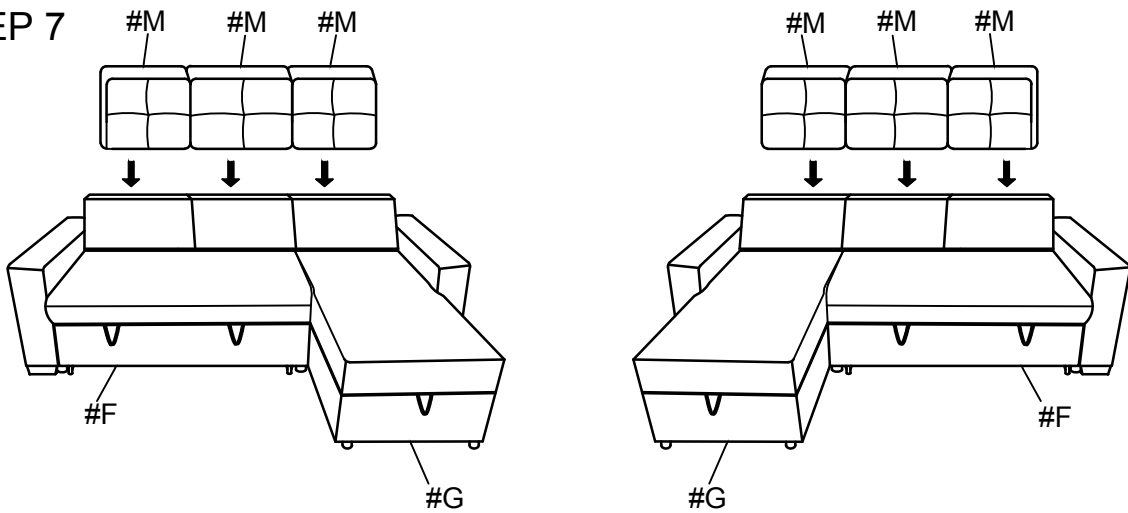

STEP 8

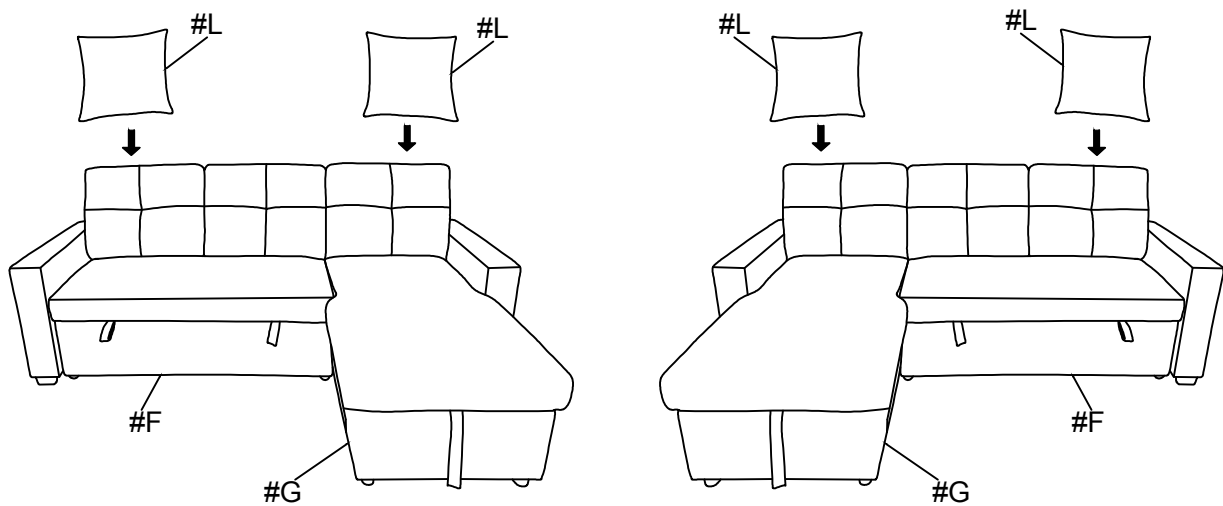

ASSEMBLY INSTRUCTIONS

STEP 9

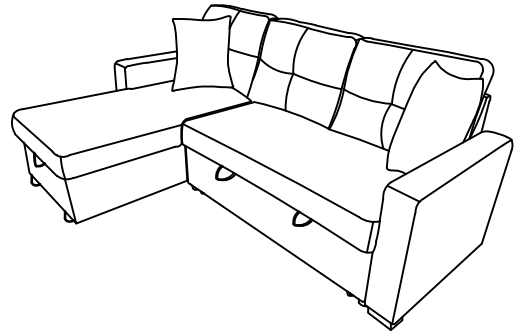
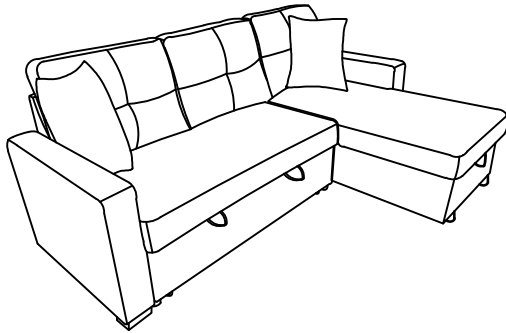

STEP 10

