

ASSEMBLY INSTRUCTIONS

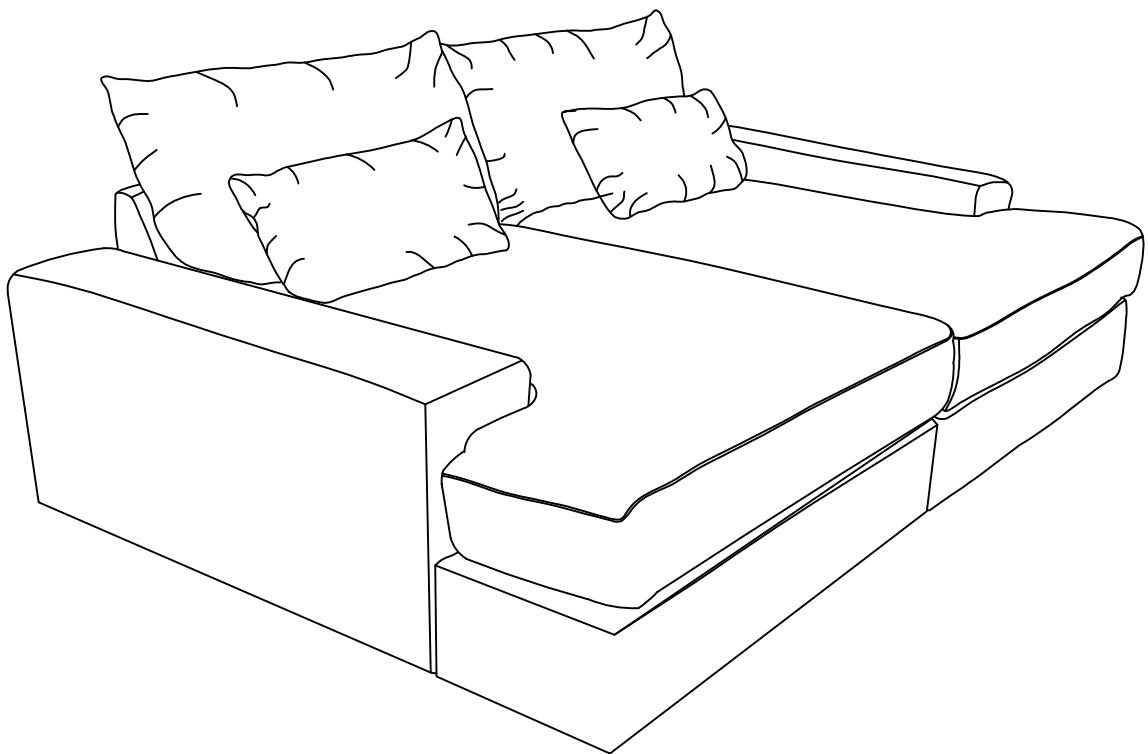



ITEMNO..81419-81420.

NOTE:

This brochure contains IMPORTANT safty info. Please read and keep for future reference.

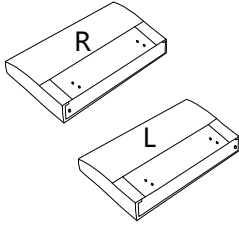
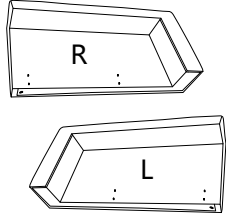
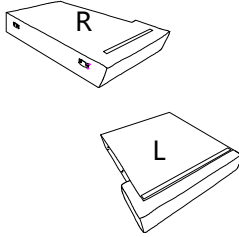
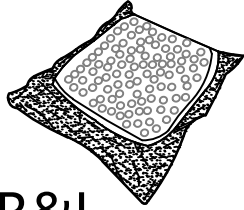
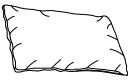
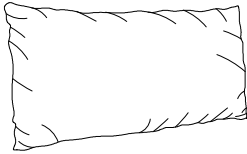
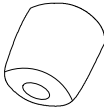
PARTS LIST

A x1	B x1	C x1	D x2
			
Backrest	Armrest	Seat frame	R&L Seat cushion
E x2	F x2	G x10	H x2
			
Pillow	Back Cushion	Legs	R&L Seat cover

HARDWARE LIST

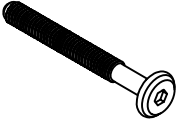
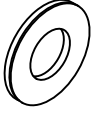
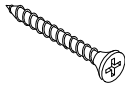
#1 x16	#2 x16	#3 x10
		
Bolts Ø1/4*50mm	Plain Washer Ø1/4*22mm	Screw #5*50mm

TOOL LIST

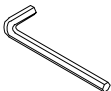
#4 x1

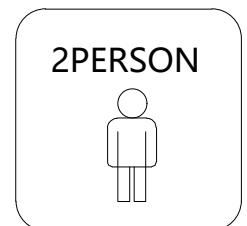
Allen Key M4

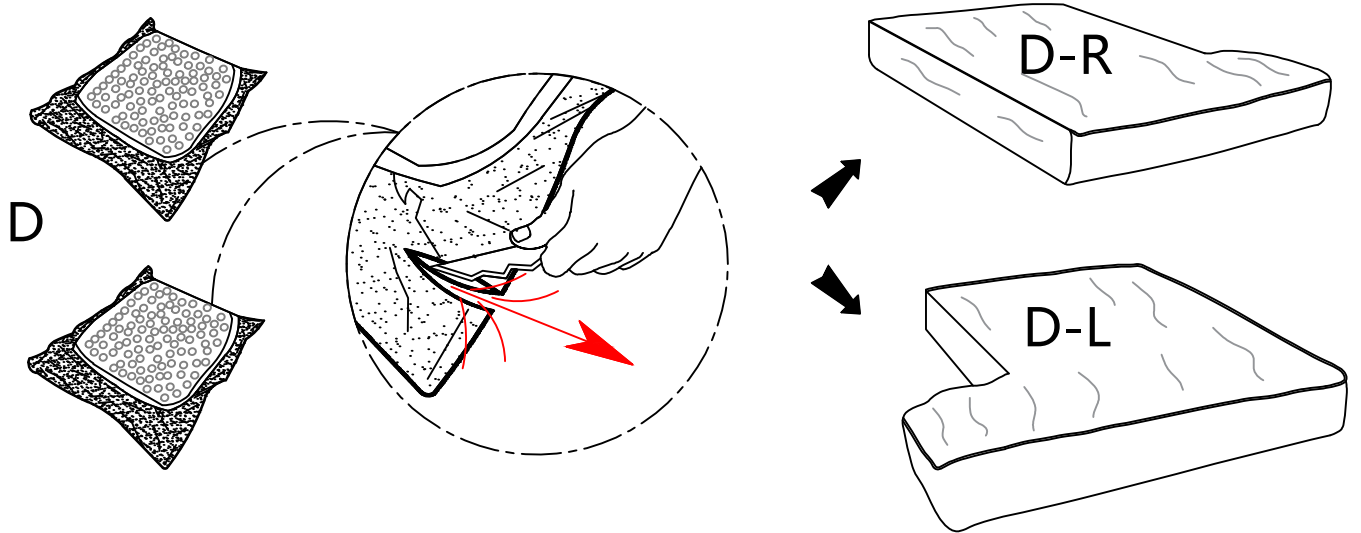

STEP 1

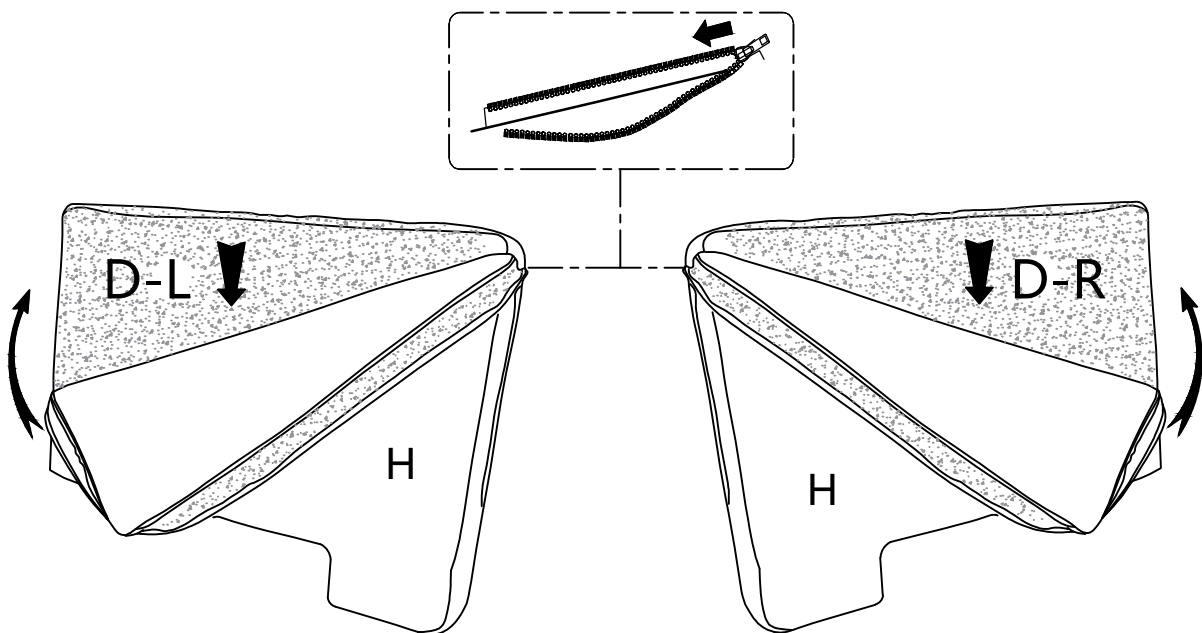

STEP 2



STEP 3

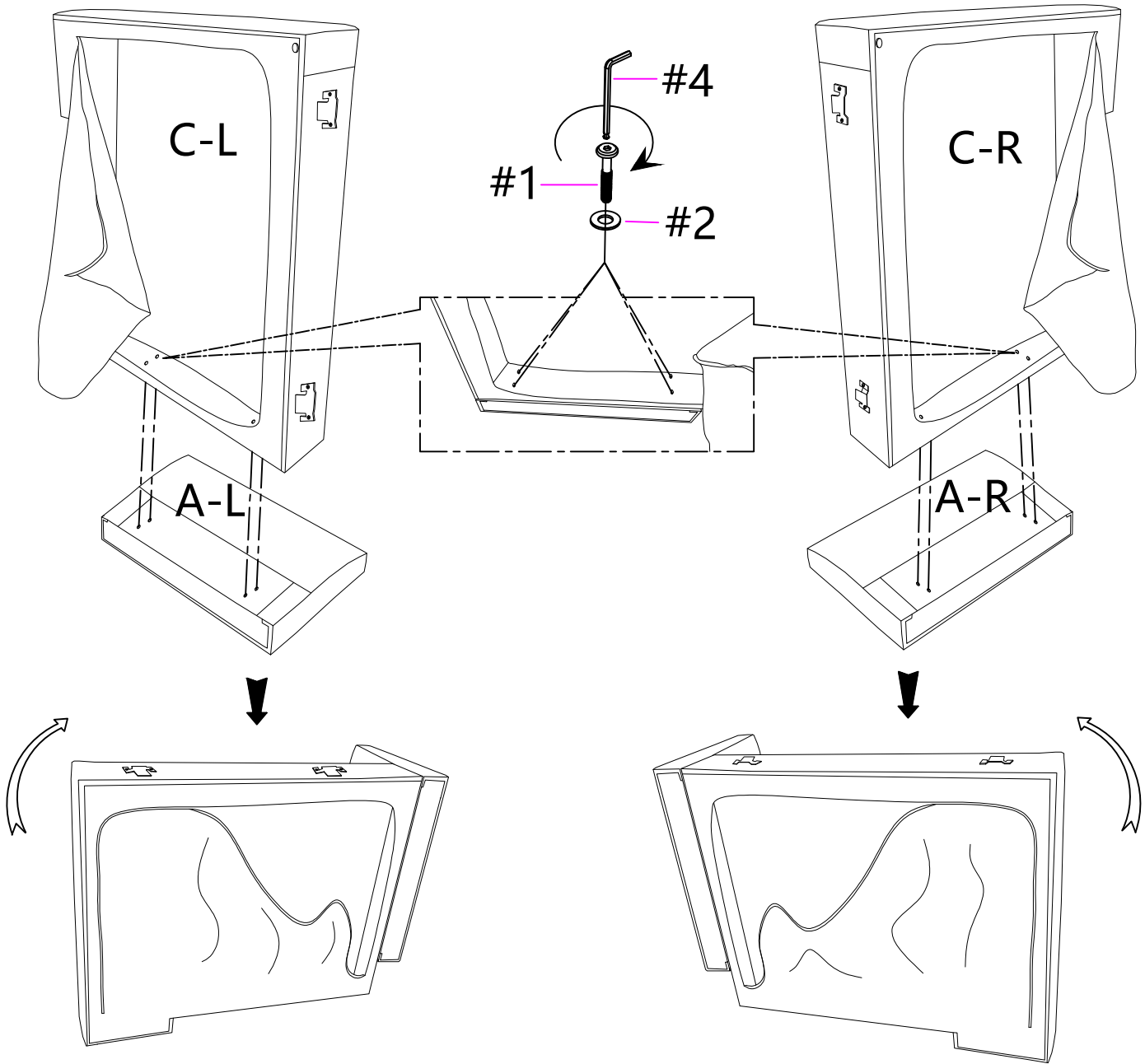

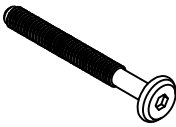
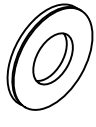
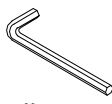
#1	x8	#2	x8	#3	x1
					
Bolts		Plain Washer		Allen Key	
Ø1/4*50mm		Ø1/4*22m		M4	

m

04/08

STEP 4

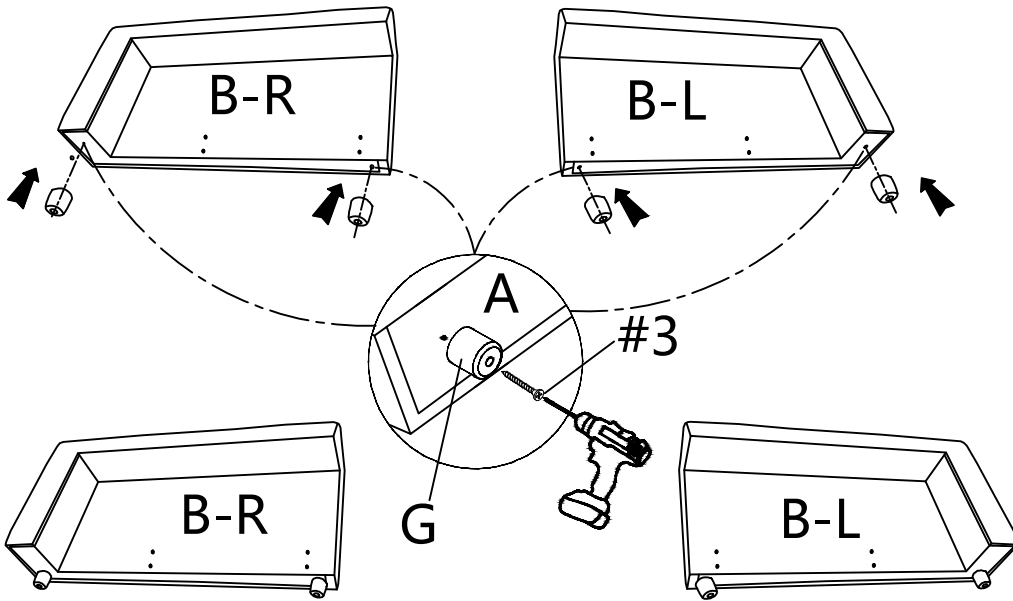

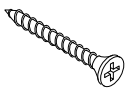

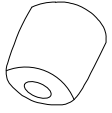
#3	x4
	
Screw	
#5*50mm	

G	x4
	
Legs	

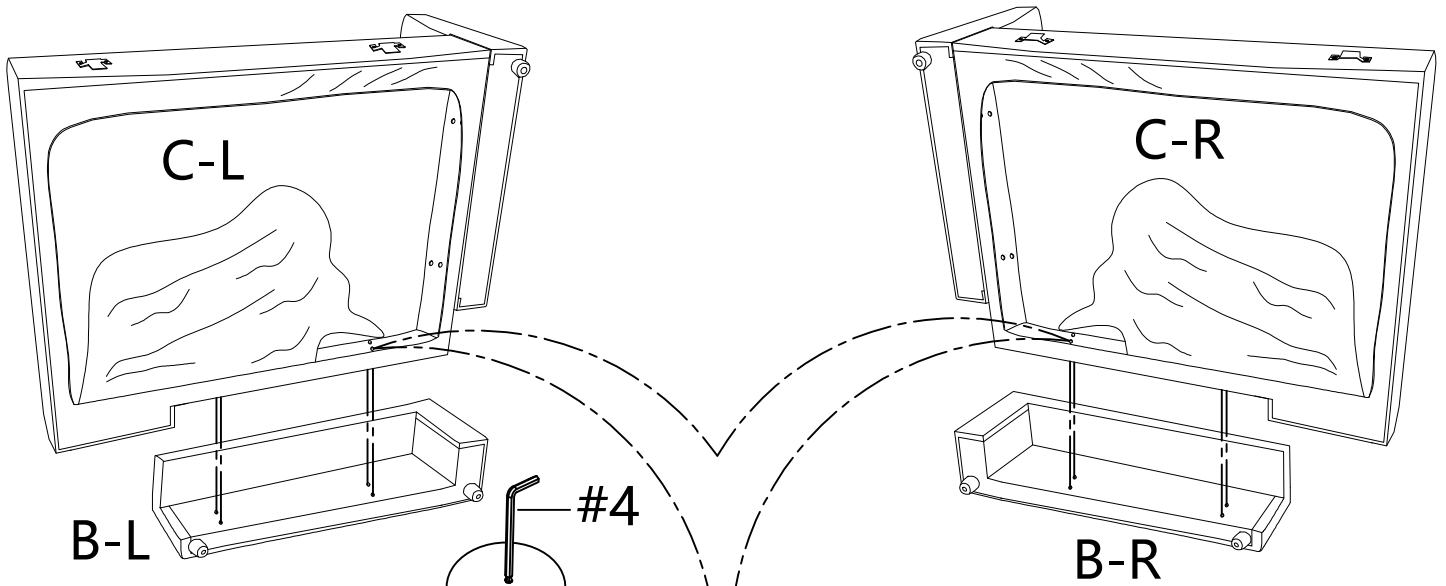
STEP 5

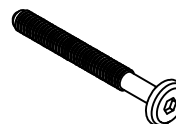

#1	x8
	
Bolts	
Ø1/4*50mm	

#2	x8
	
Plain Washer	
Ø1/4*22m	

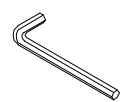
#3	x1
	
Allen Key	
M4	

m

STEP 6

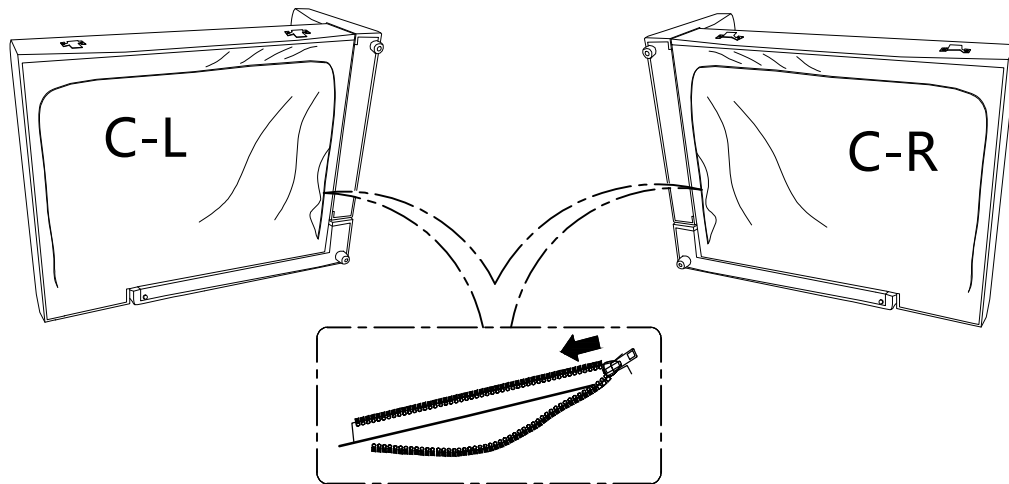

STEP 7

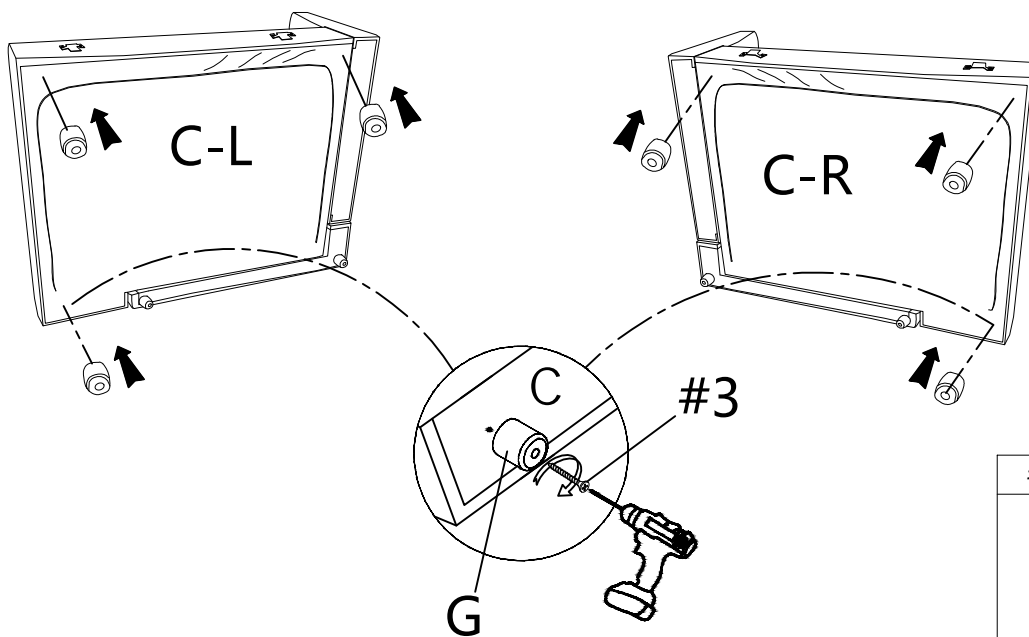

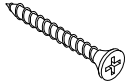
#3	x6
	
Screw #5*50mm	

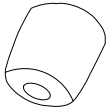
G	x6
	
Legs	

STEP 8

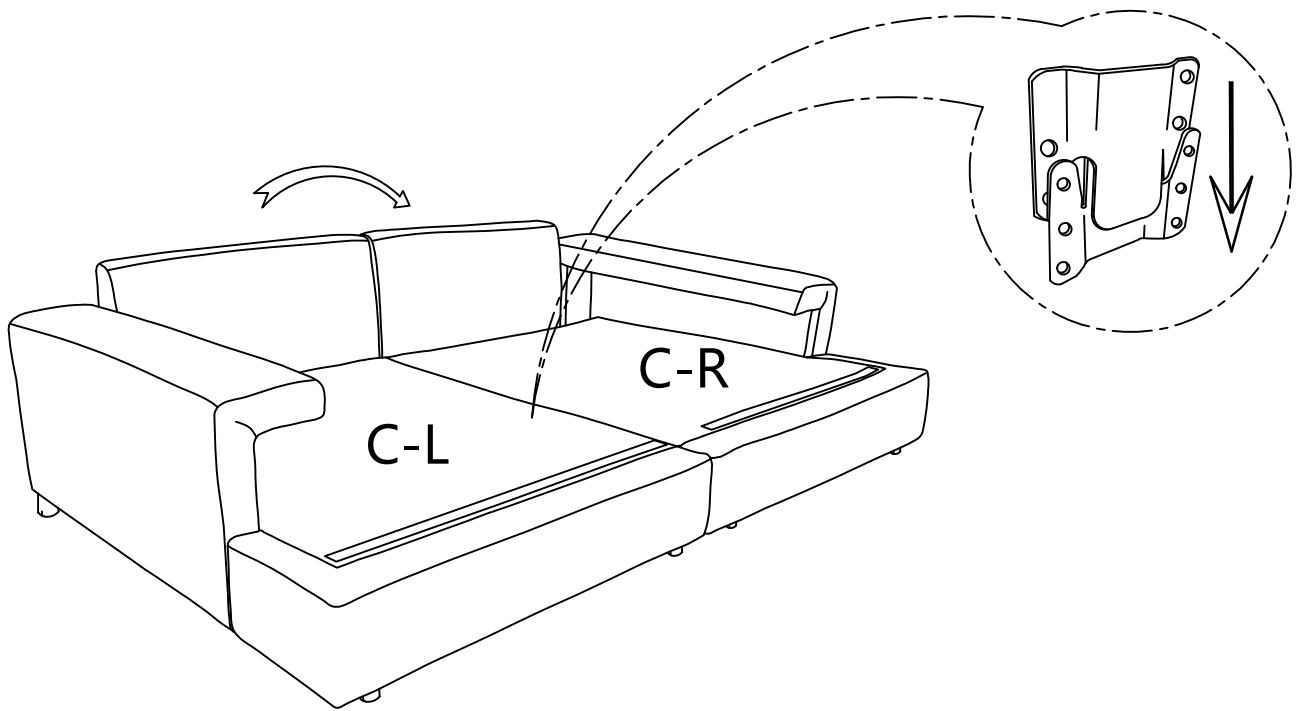

STEP 9

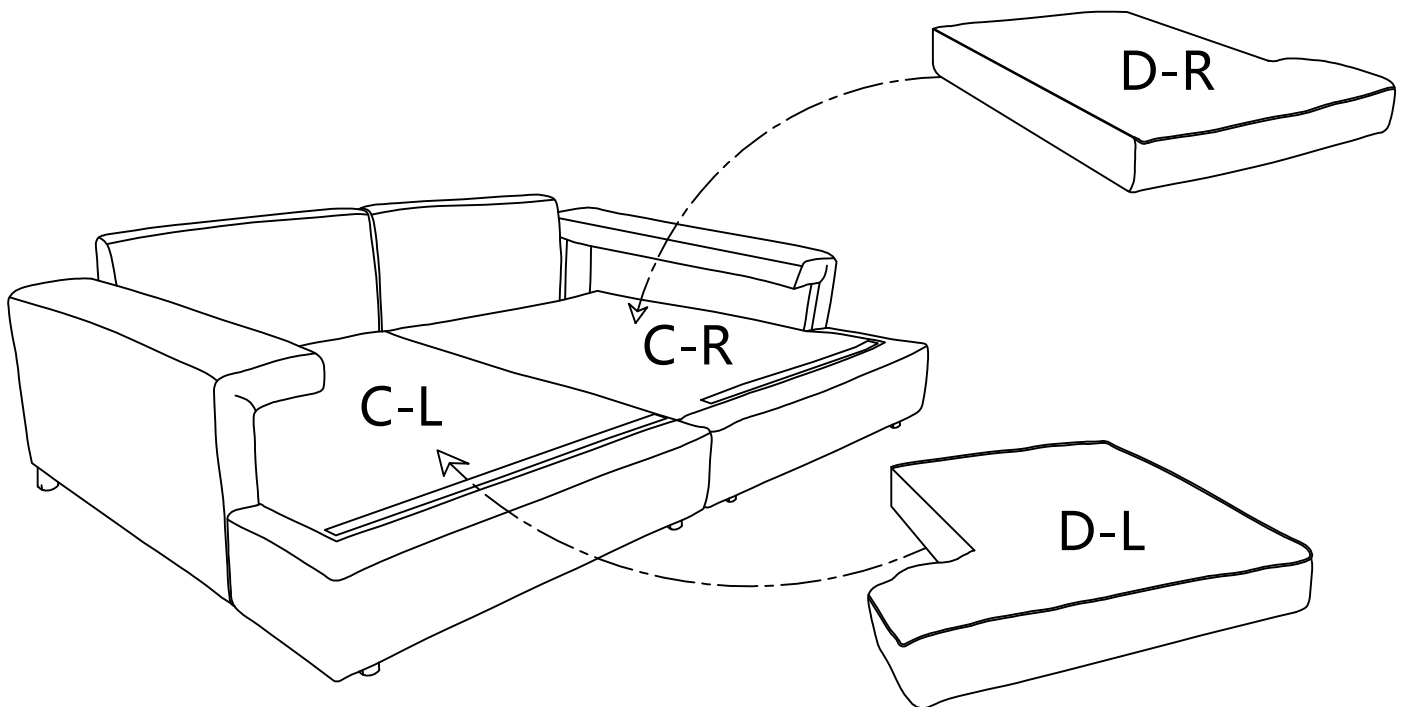

STEP 10

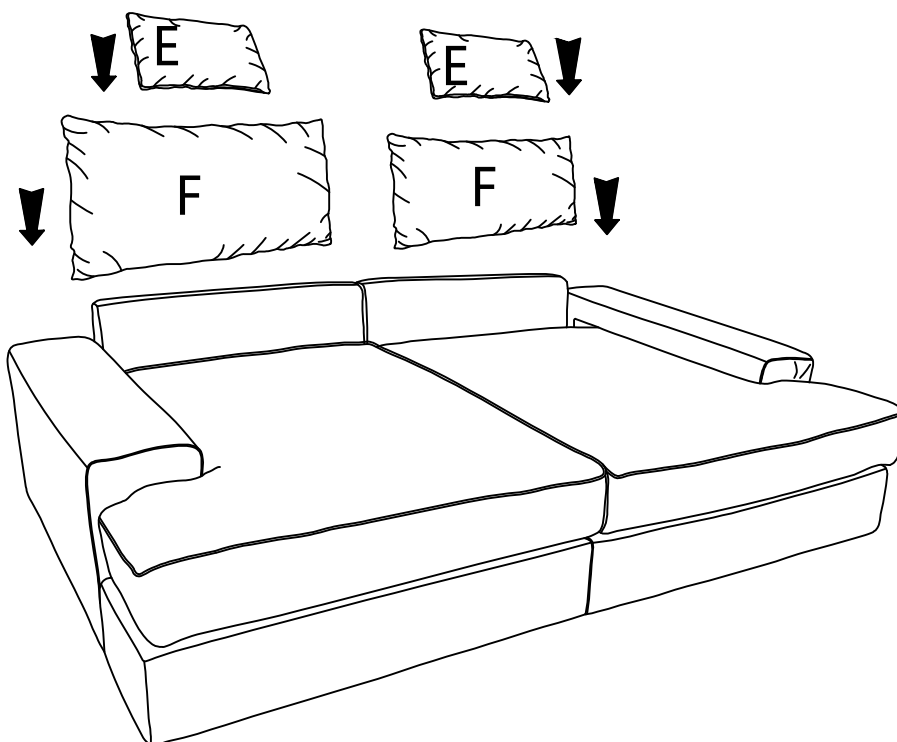

COMPLETED

