

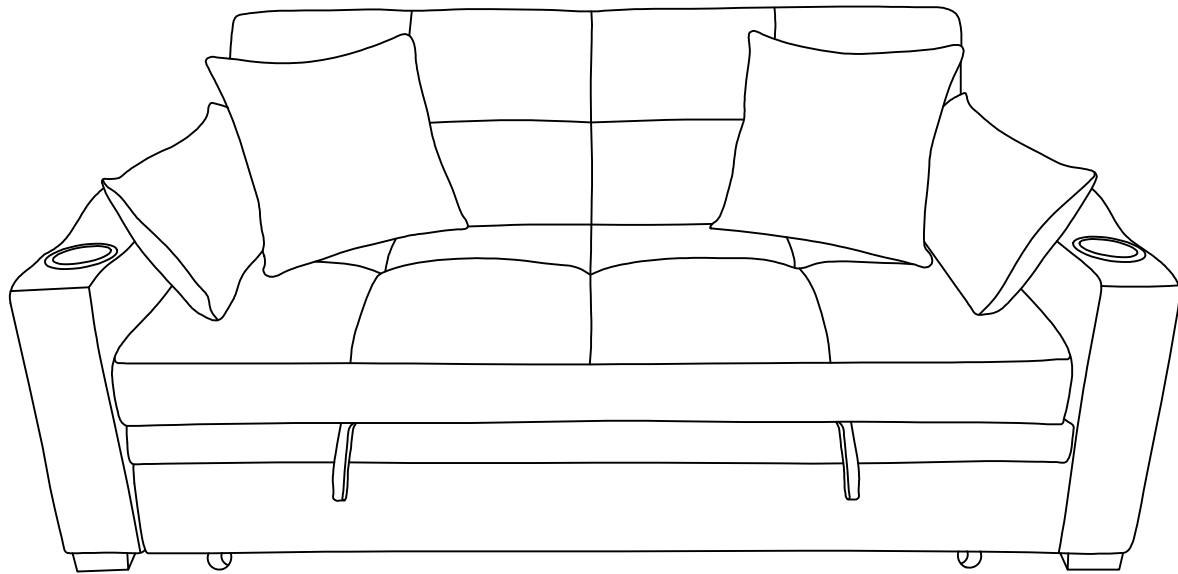

# Assembly Instructions



ITEM NO.: 81450/81451

**IMPORTANT: PLACE ALL PARTS ON A CLEAN AND SMOOTH SURFACE SUCH AS A RUG OR CARPET TO AVOID THE PARTS FROM BEING SCRATCHED KINDLY FOLLOW THE ASSEMBLY INSTRUCTIONS STEP DO NOT TIGHTEN ALL SCREWS UNTIL THE CHAIR IS FULLY SET-UP**





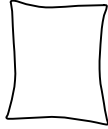
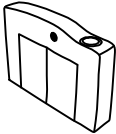

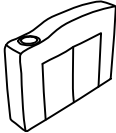
# ASSEMBLY INSTRUCTIONS



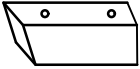
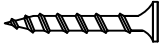



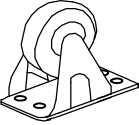

## PARTS LIST

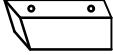
PART	DRAWING	DESCRIPTION	QTY	PART	DRAWING	DESCRIPTION	QTY
A		Love Seat	1	D		Pillow	2
B		Left Arm	1	E		Pillow	2
C		Right Arm	1				

## HARDWARE LIST

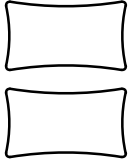
PART	DRAWING	DESCRIPTION	QTY	PART	DRAWING	DESCRIPTION	QTY
F		Legs	4	K		Screw M4 x 25MM	16
G		Bolt (Ø5/16" X70MM)	4	L		Allen key (M5)	1
H		Spring washer (Ø5/16"	4	M		Wooden pegs	4
I		Roller	4				

# 81450-81451 is packed in 2 cases

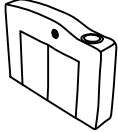
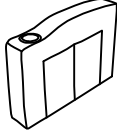
Carton	Disignation	Part		Hardware	
81450/81451-1	Love seat	#A		 #Fx4pcs	 #Gx4pcs
	Cushion	#D		 #Hx4pcs	 #Ix4pcs
	Cushion	#E		 #Kx16pcs	 #Lx1pc  #Mx4pcs
81450/81451-2	Left arm	#B			
	Right arm	#C			

# ASSEMBLY INSTRUCTIONS

## STEP 1

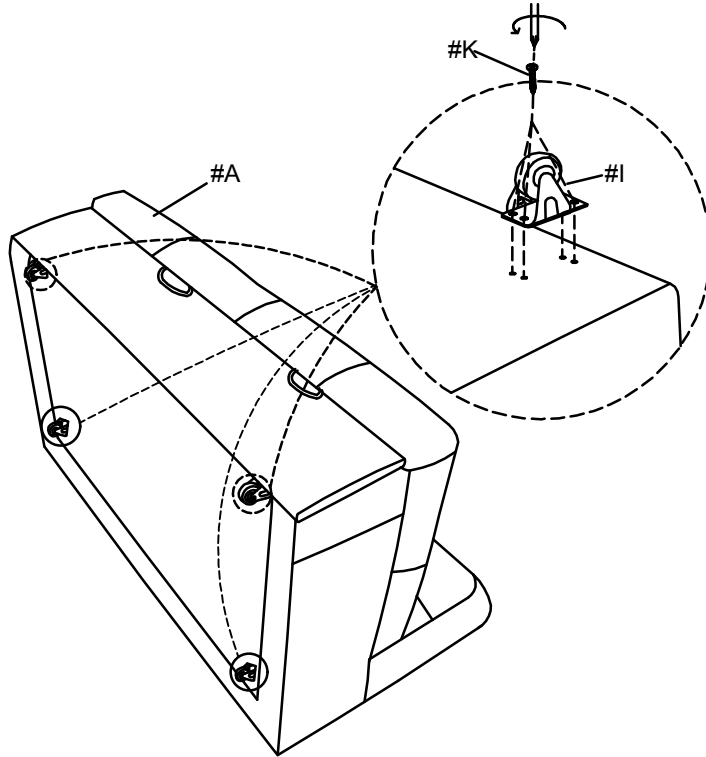

## STEP 2

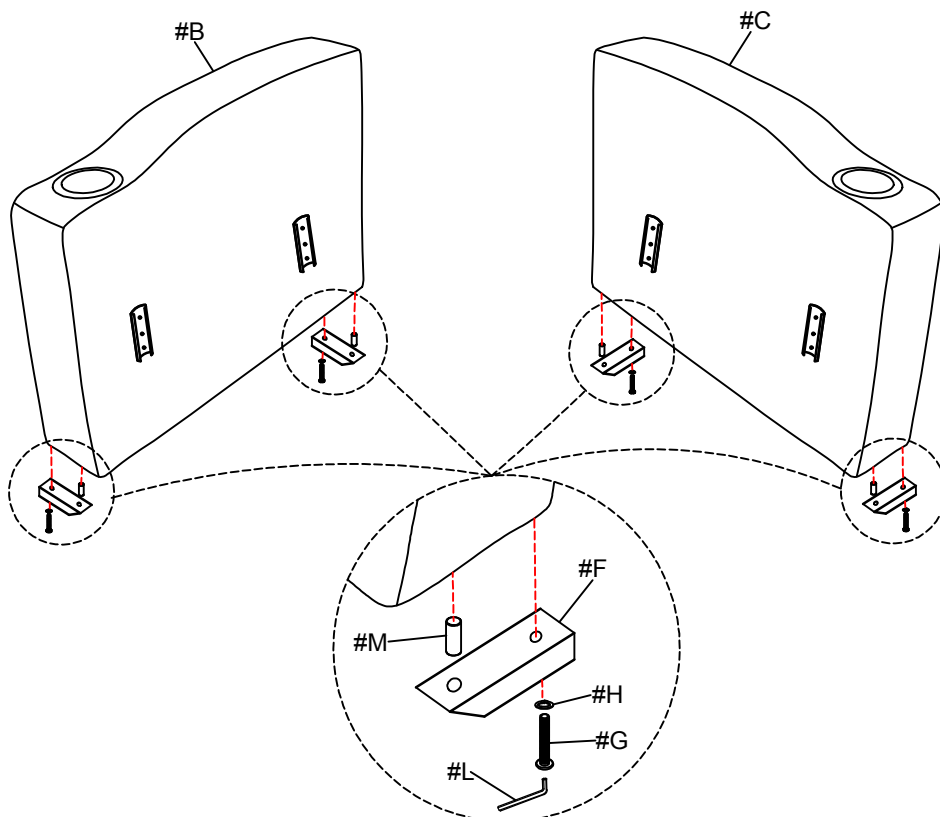

# ASSEMBLY INSTRUCTIONS

## STEP 2

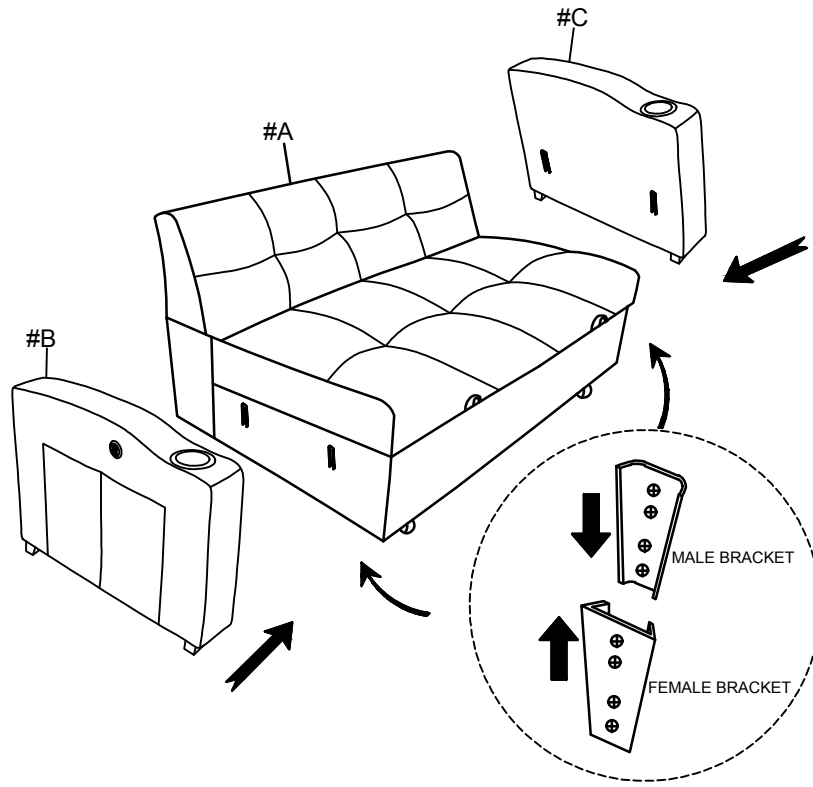

## STEP 3

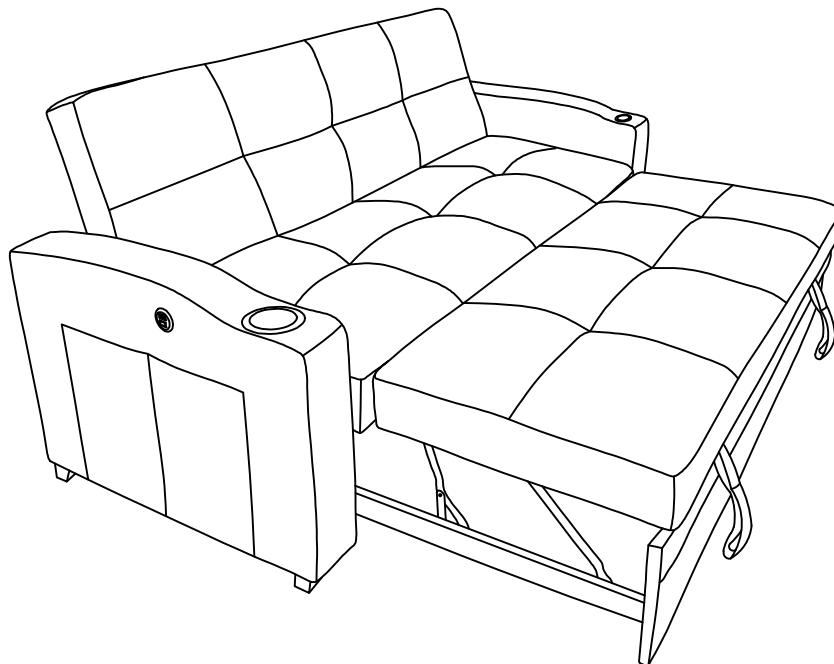

# ASSEMBLY INSTRUCTIONS

## STEP 4

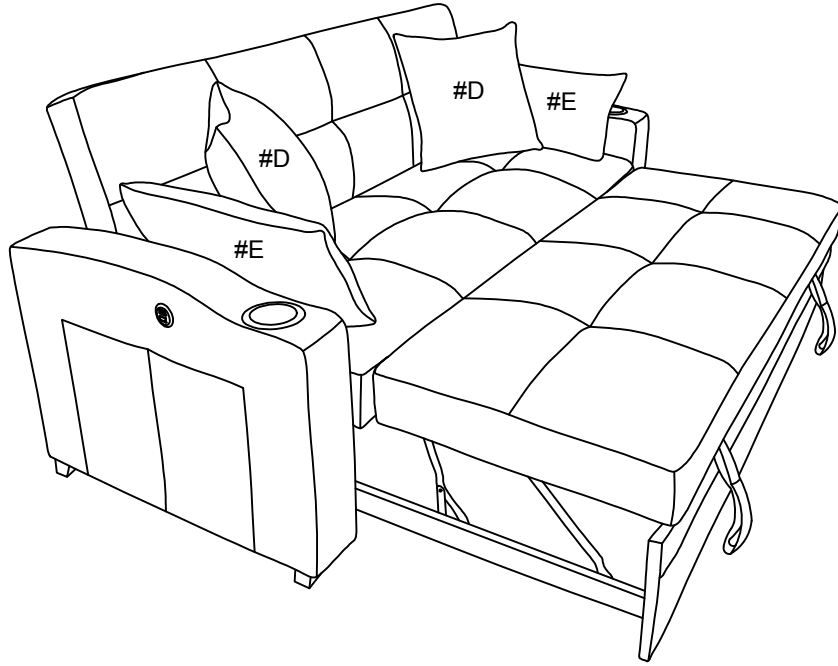

## STEP 5

