

ASSEMBLY INSTRUCTION

ITEM NO.: 81480

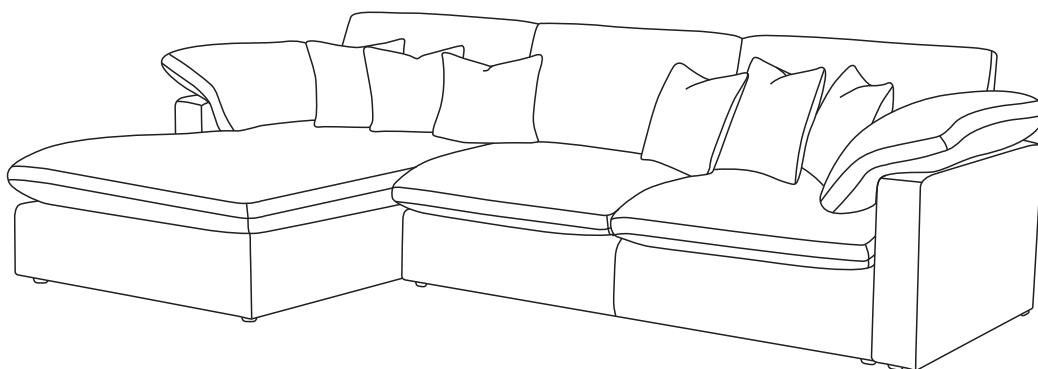

PARTS LIST

A X1	B X1	C X2	D X1	E X1	F X1
G X2	H X1	I X2	J X1	K X2	L X6

HARDWARE LIST



1 X15

BOX-1

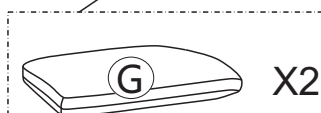
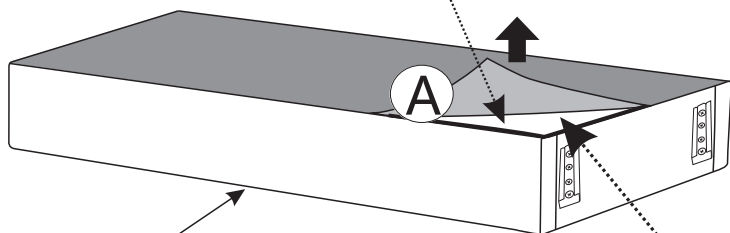
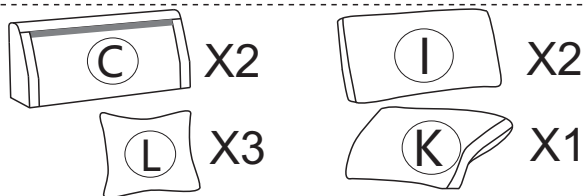

BOX-2

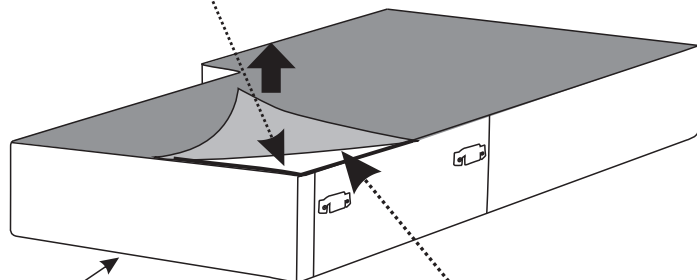
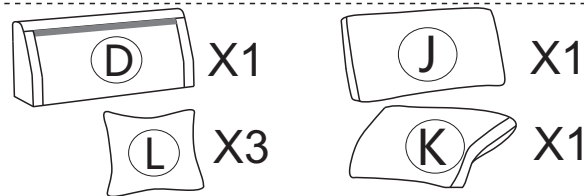

BOX-3

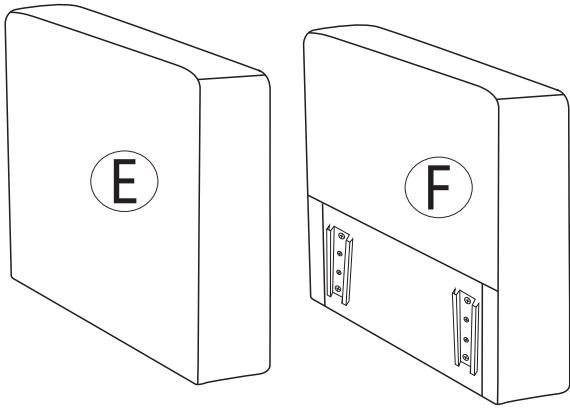

Step1

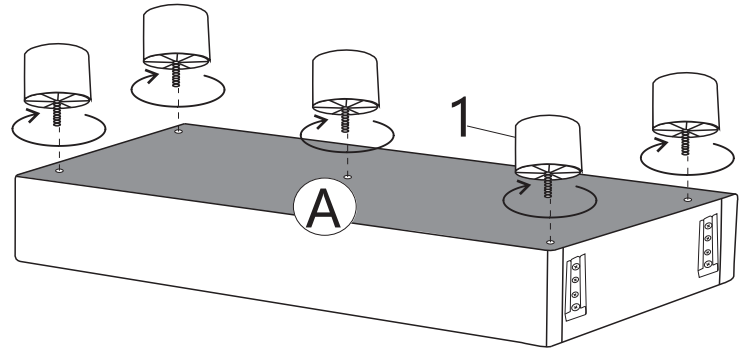

Step2

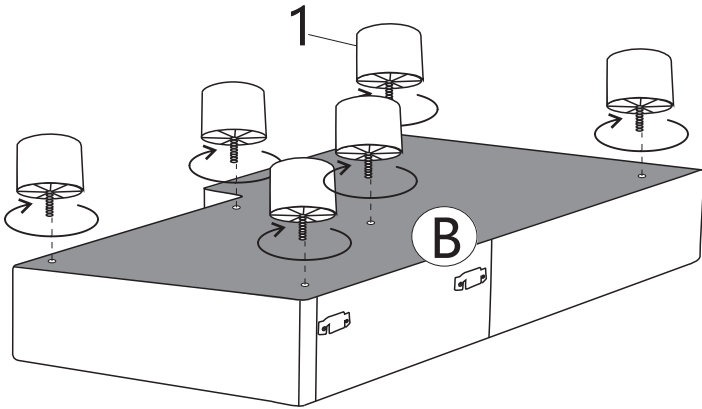

Step3

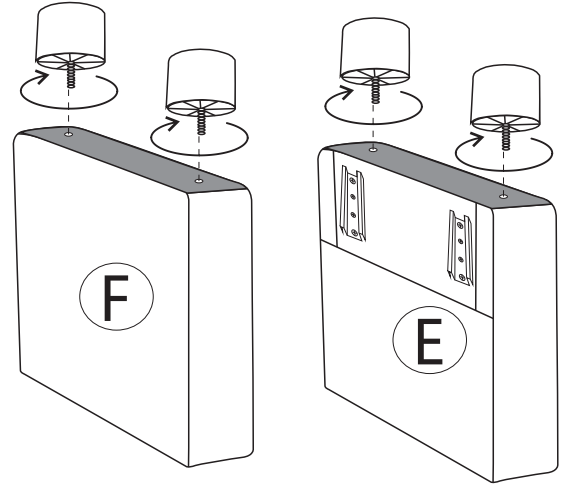

Step4

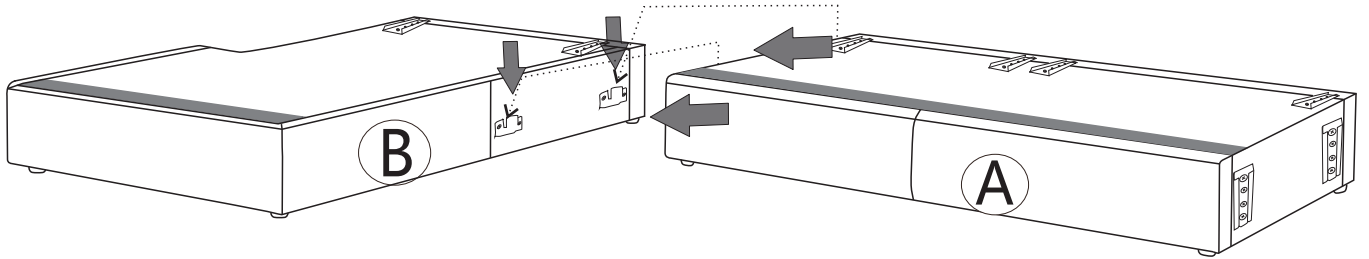

Step5

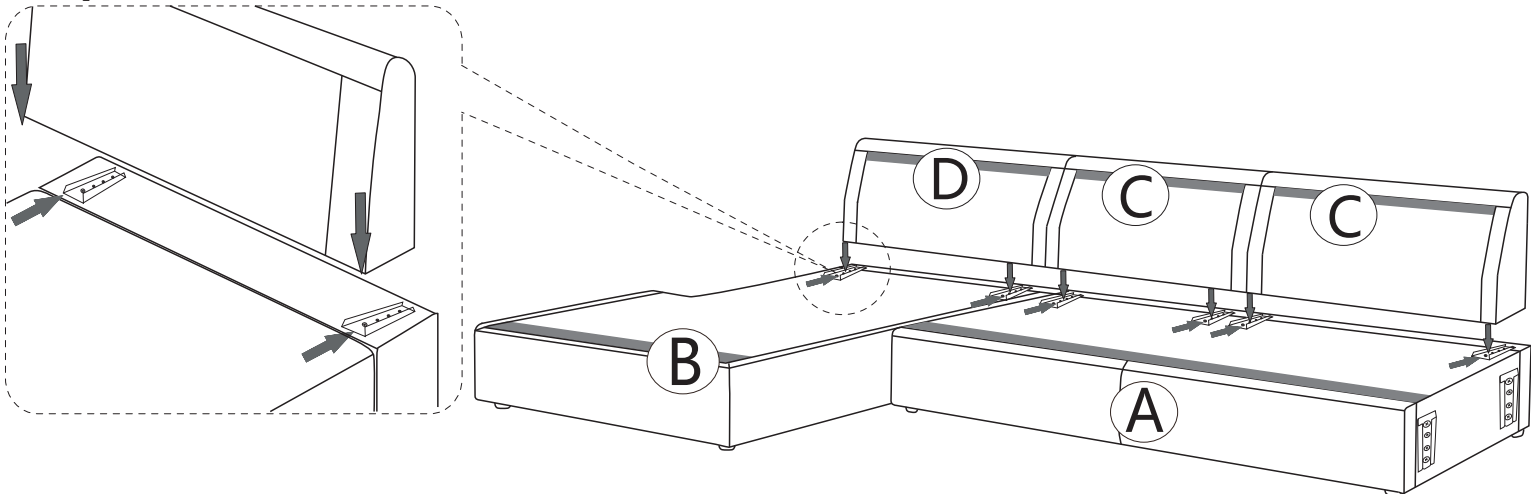

Step6

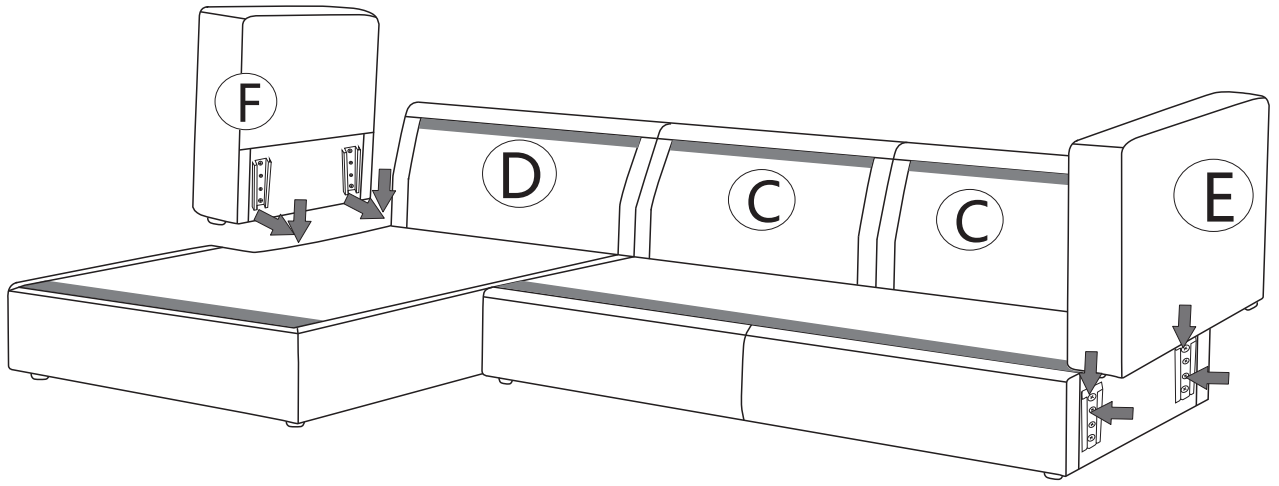

Step7

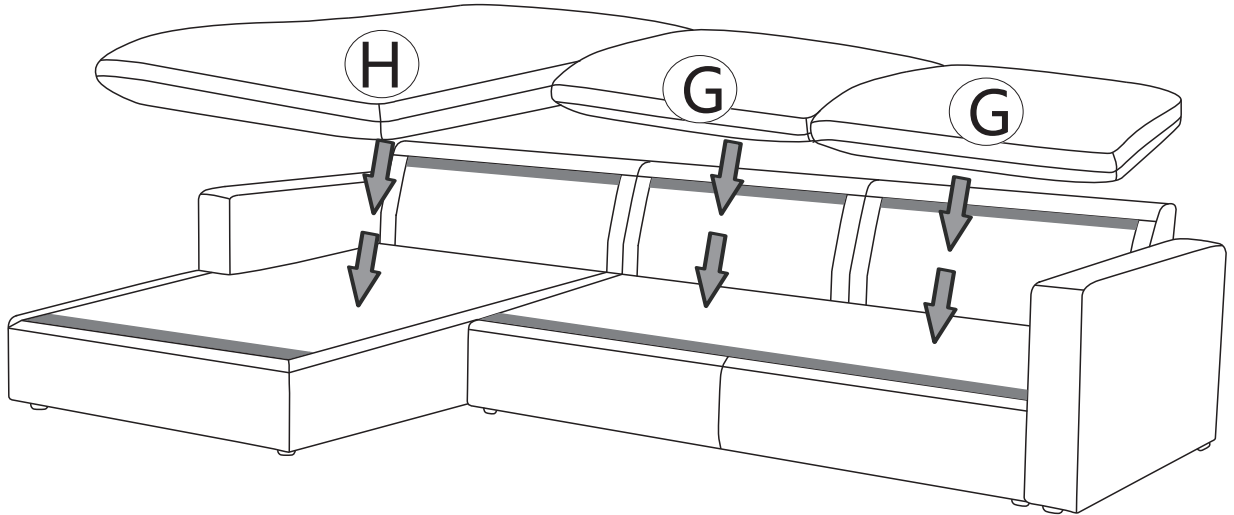

Step8

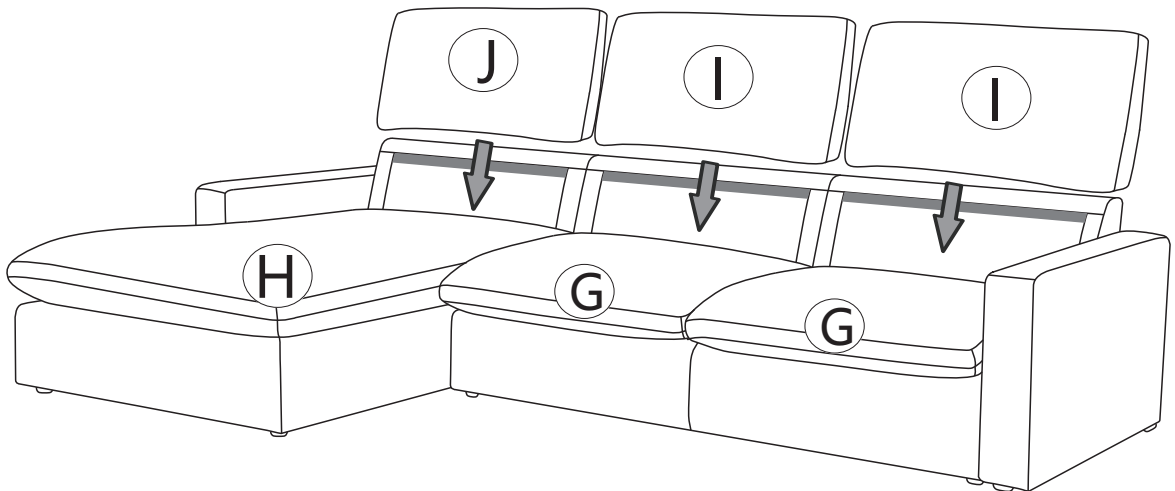

Step9

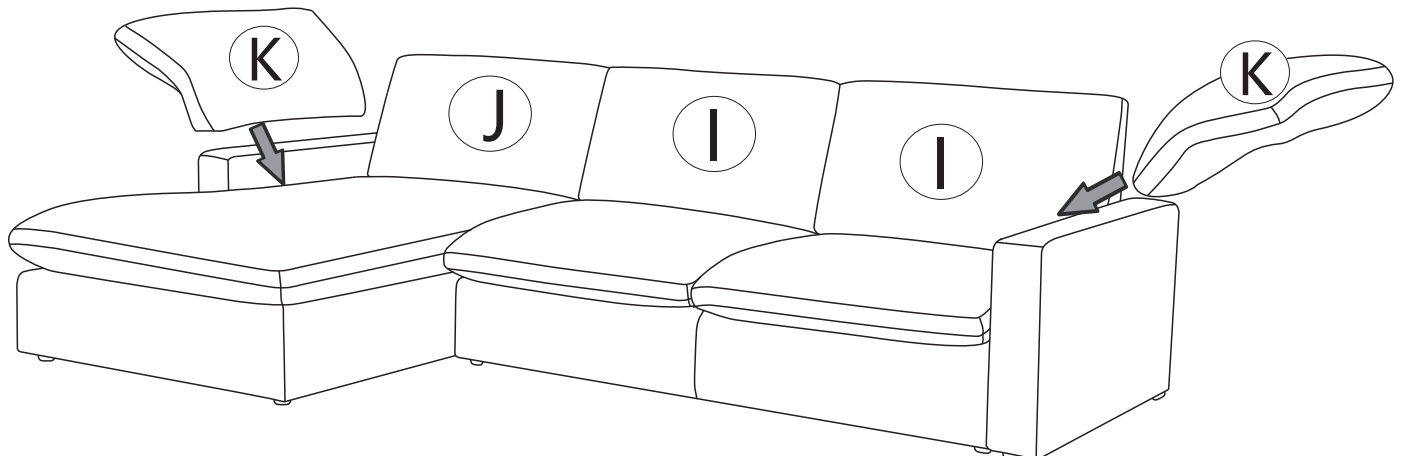

Step 10

