

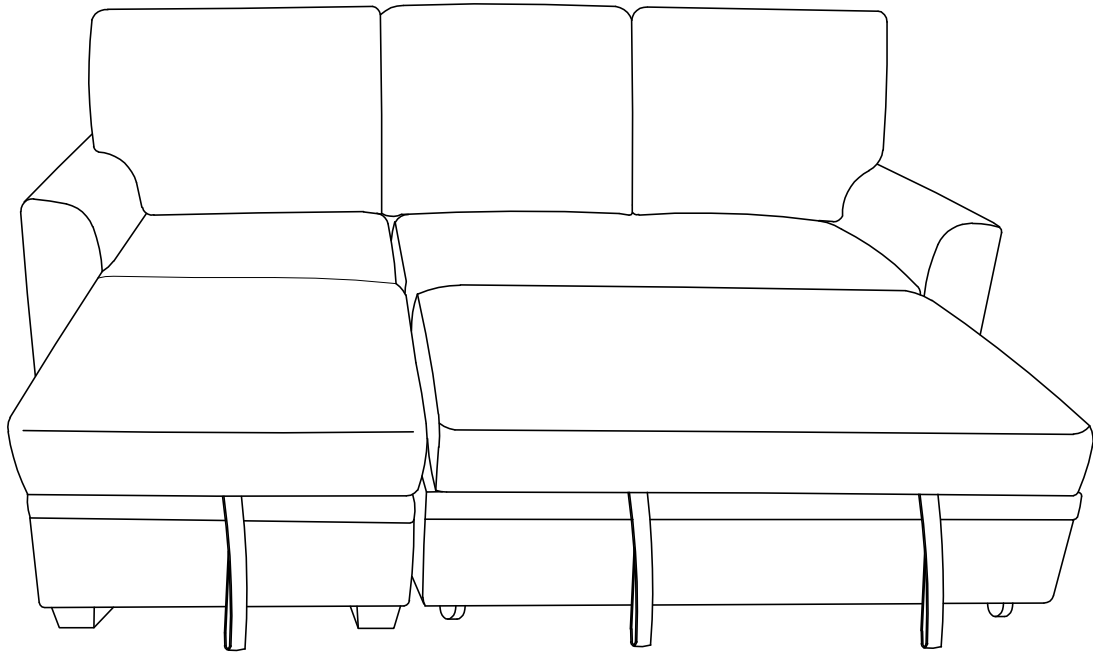

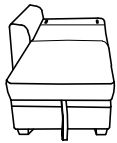

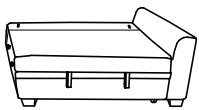

ASSEMBLE INSTRUCTION

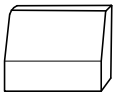
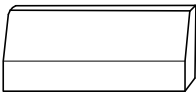
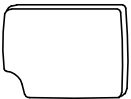

A x1PC 	B x1PC 	C x1PC 	D x1PC 	E x1PC 
F x1PC 	G x7PCS 	H x2PCS 	J x4PCS 	K x1PC 

Step 1

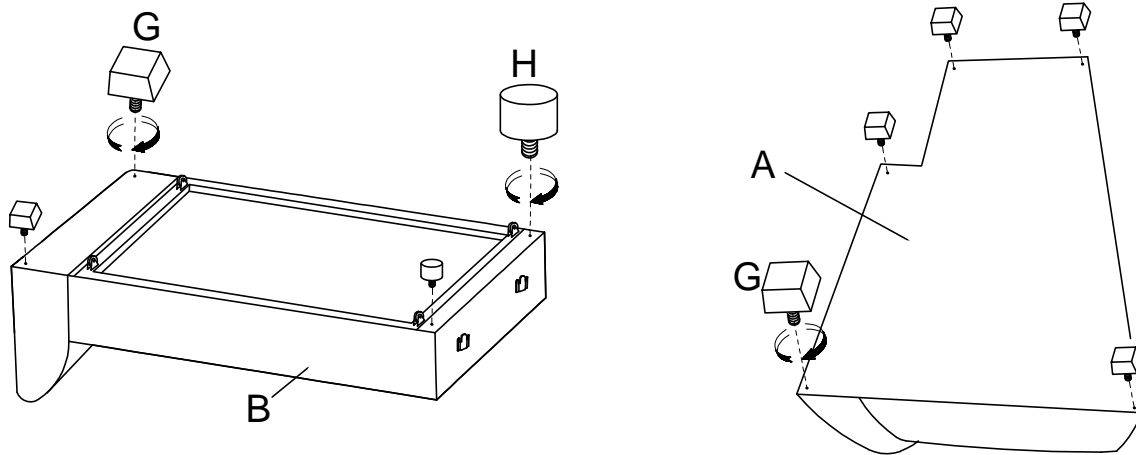

Step 2

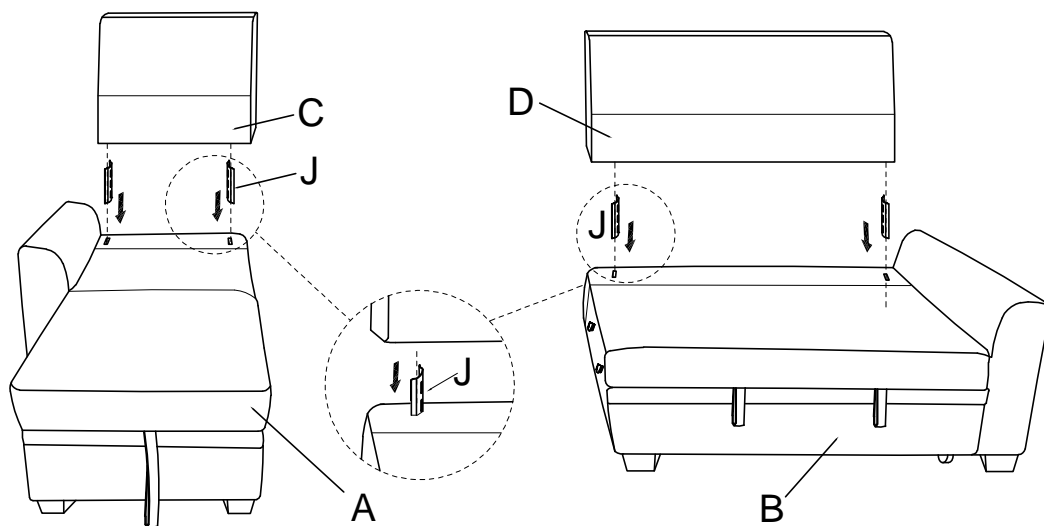

Step 3

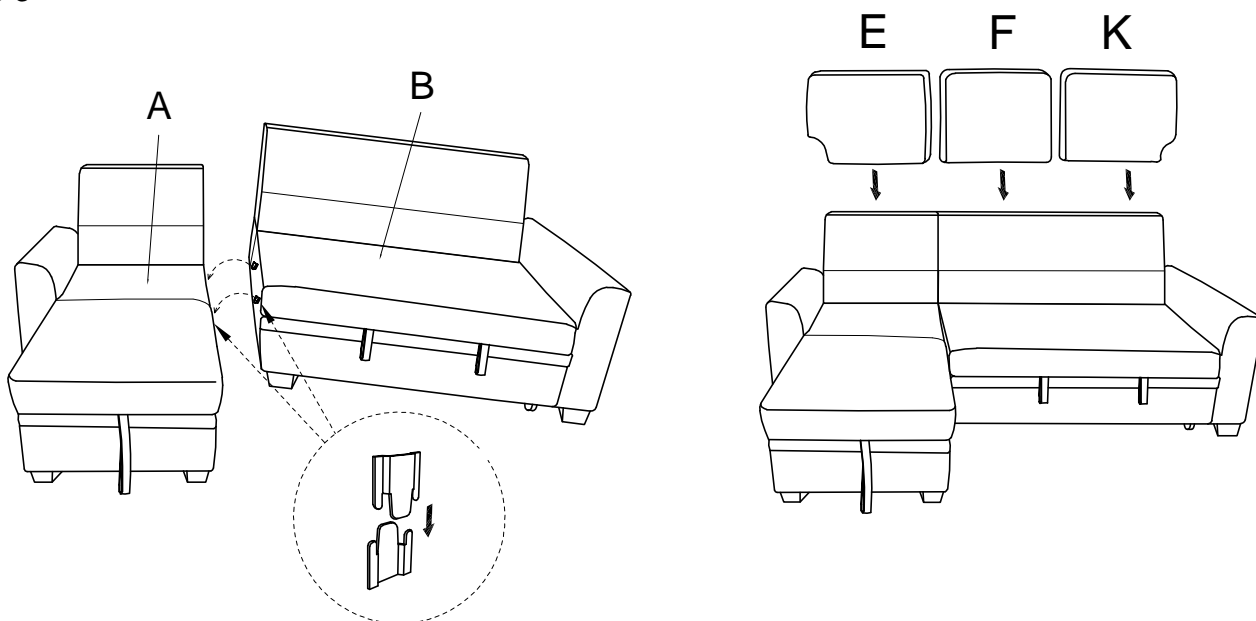

Step 4

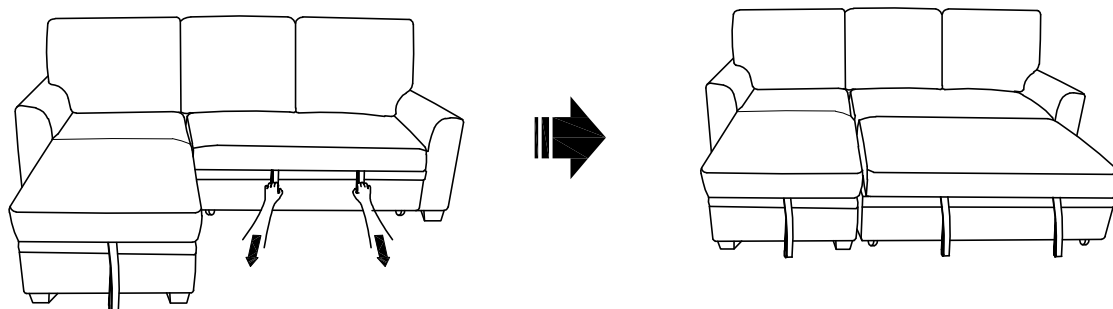

Step 5

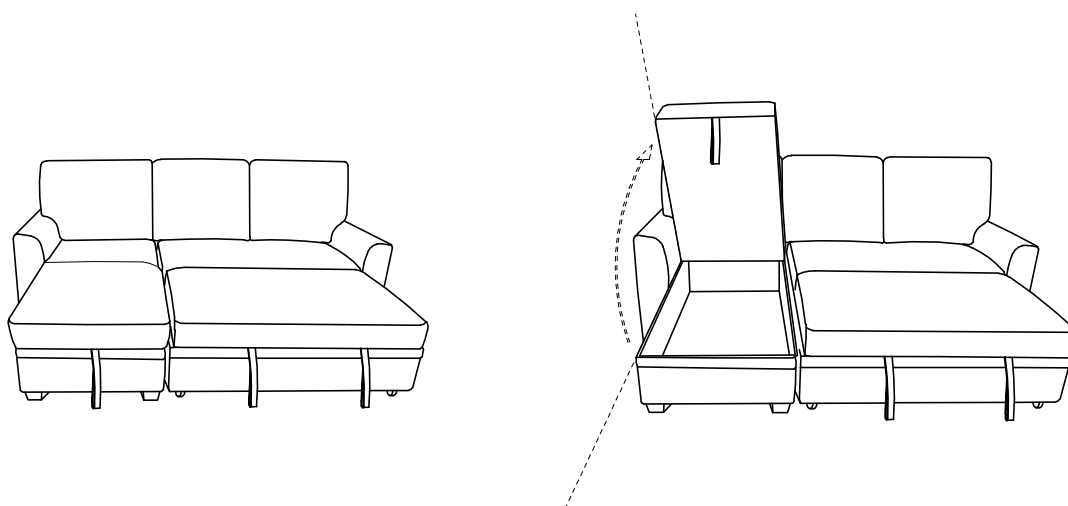

Step 6

