

# ASSEMBLY INSTRUCTION

ITEM NO.:

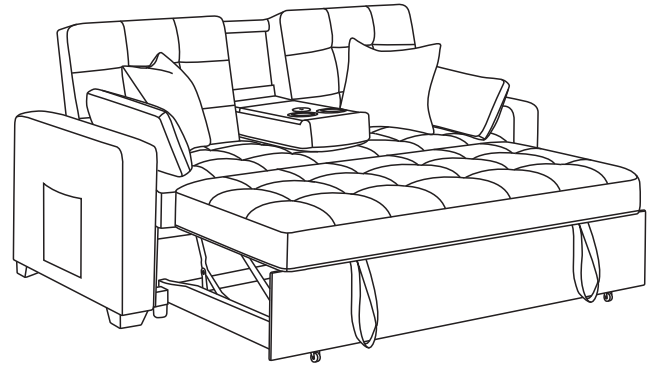
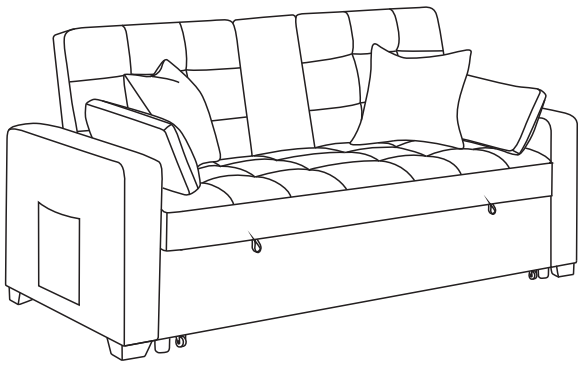

## PARTS LIST

<b>A</b>	<b>B</b>	<b>C</b>	<b>D</b>	<b>E</b>
x1	x1	x1	x2	x2

## HARDWARE LIST

<b>1</b>	<b>2</b>	<b>3</b>	<b>4</b>	<b>5</b>
M6X25		M4		
x8	x8	x1	x4	x4
<b>6</b>	<b>7</b>	<b>8</b>	<b>9</b>	
	M8X60	M5		
x4	x4	x1	x1	

Step1

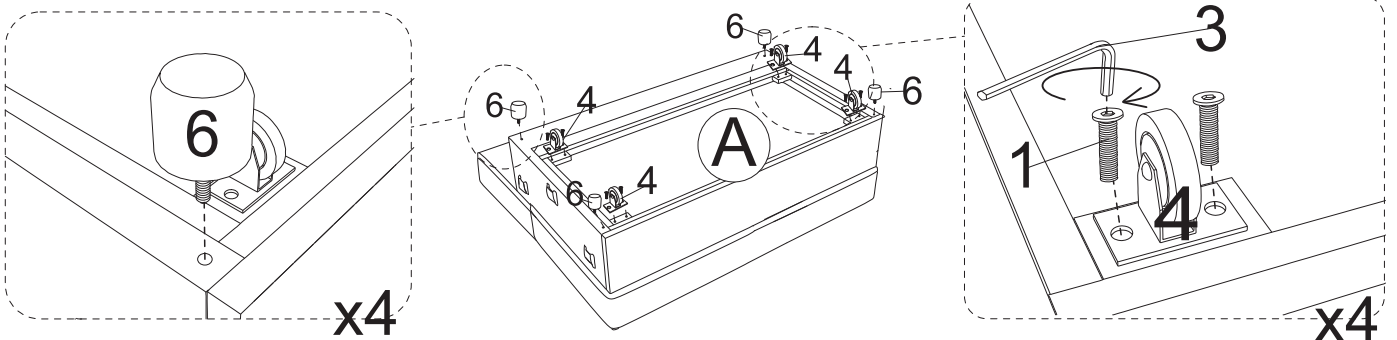

Step2

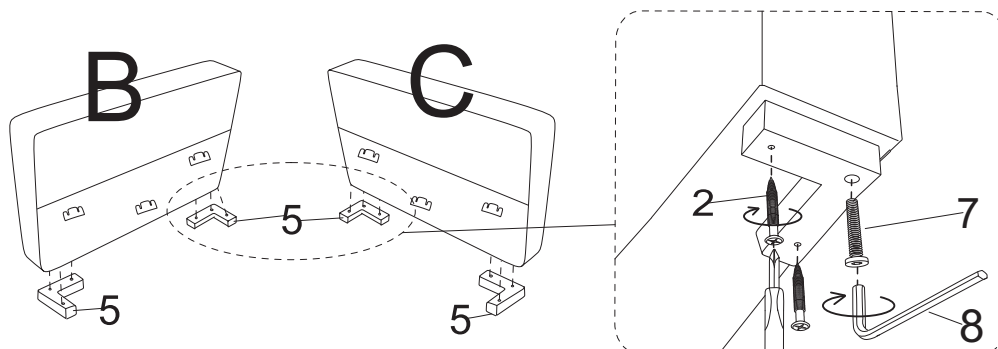

Step3

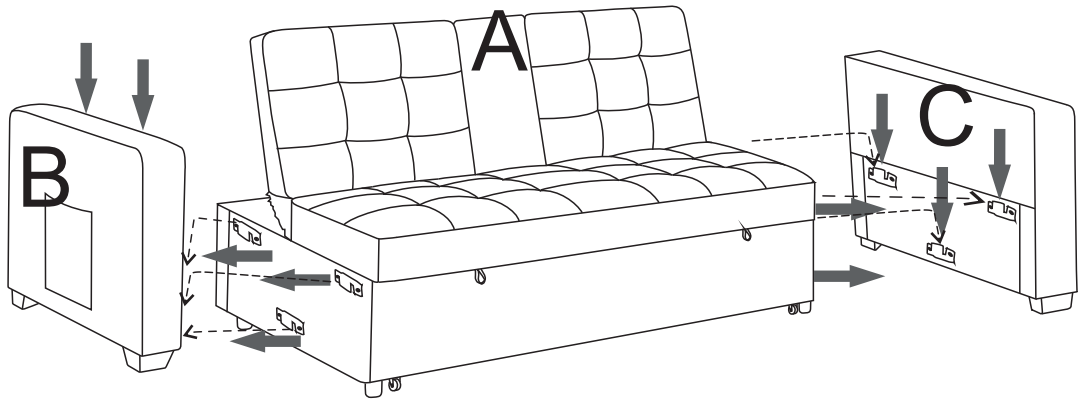

Step4

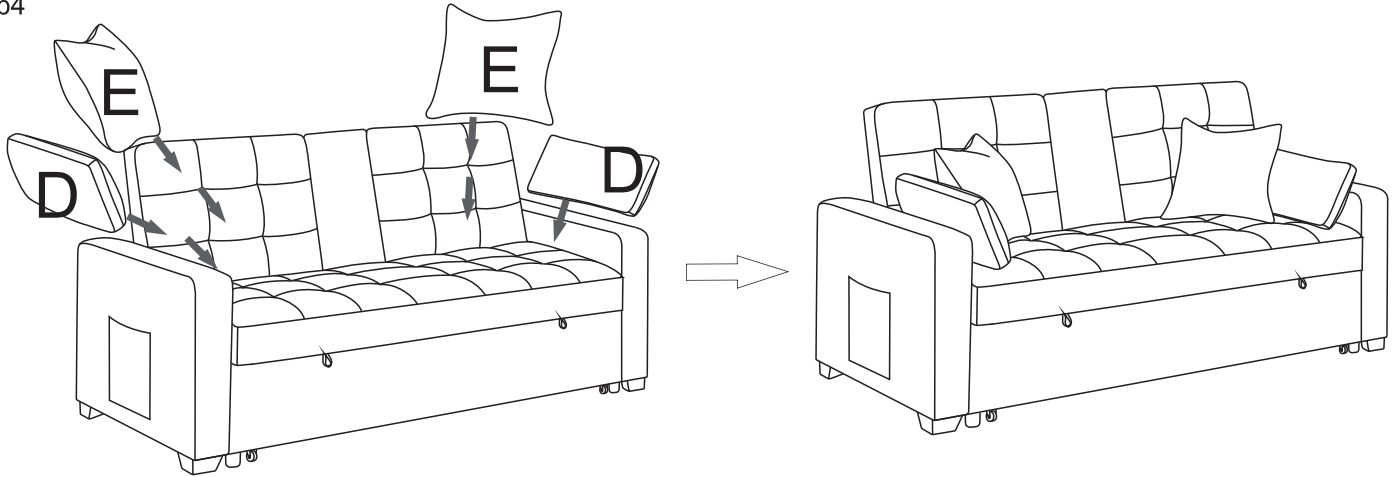

Step5

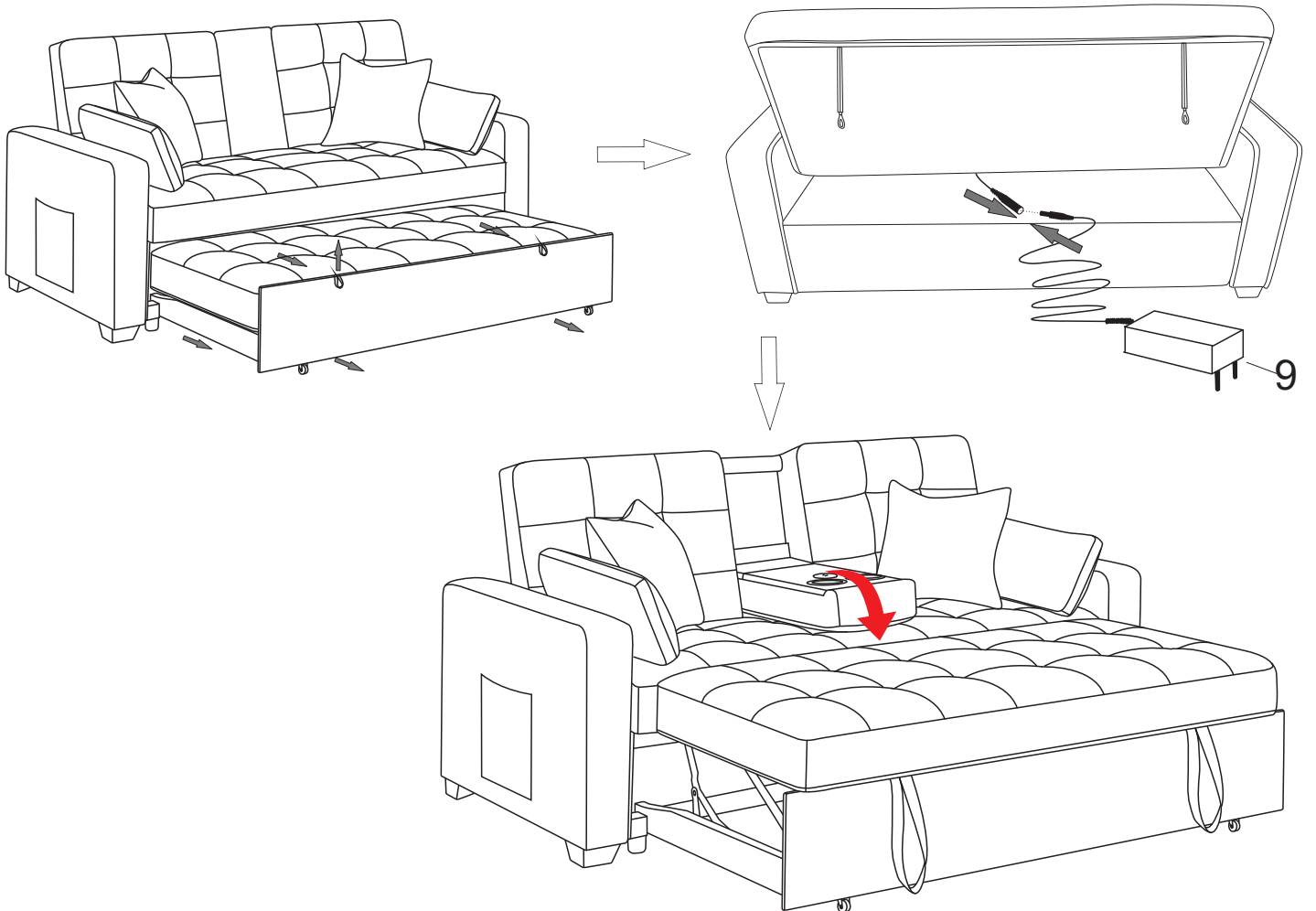

Step 6

