

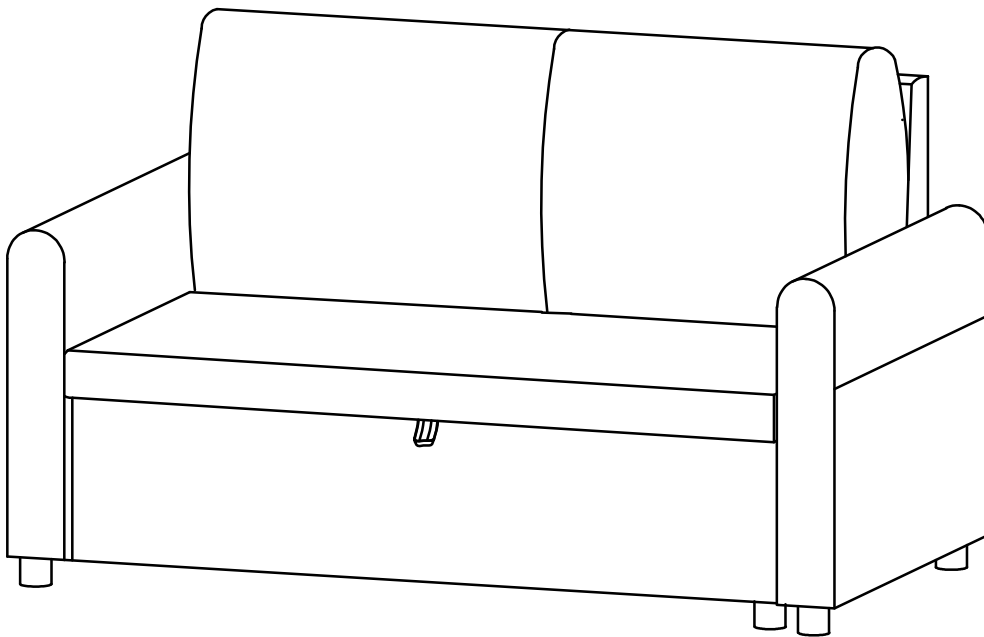









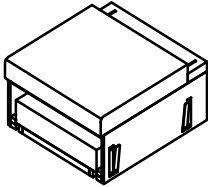
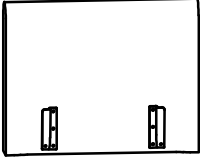
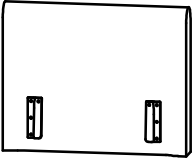
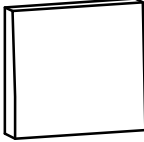

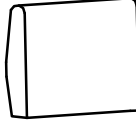
LOVESEAT

ASSEMBLY INSTRUCTIONS

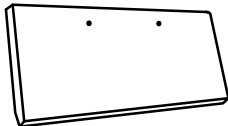
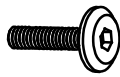

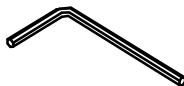
Part No.	Part	Qty	Image	Part No.	Part	Qty	Image
A	Sofa Frame	1		B	Chair Frame	None	
C	Sofa Arm	1		D	Chair Arm	1	
E	Sofa Back	2		F	Chair Back	None	
G	Sofa Back Cushion	2		H	Chair Back Cushion	None	
J	Plastic Leg	8		K	Washer	8	
L	Lock Latches	4		M	Chair Front Fender	none	
N	Allen Bolt	None		O	Allen Washer	None	
P	Allen Wrench	None					

Step1:Take out the Sofa Back Cushion (G)x2 & Sofa Back (E) x2 & The hardware package from Sofa Frame (A) , legs & hardware would be found in the hardware package.

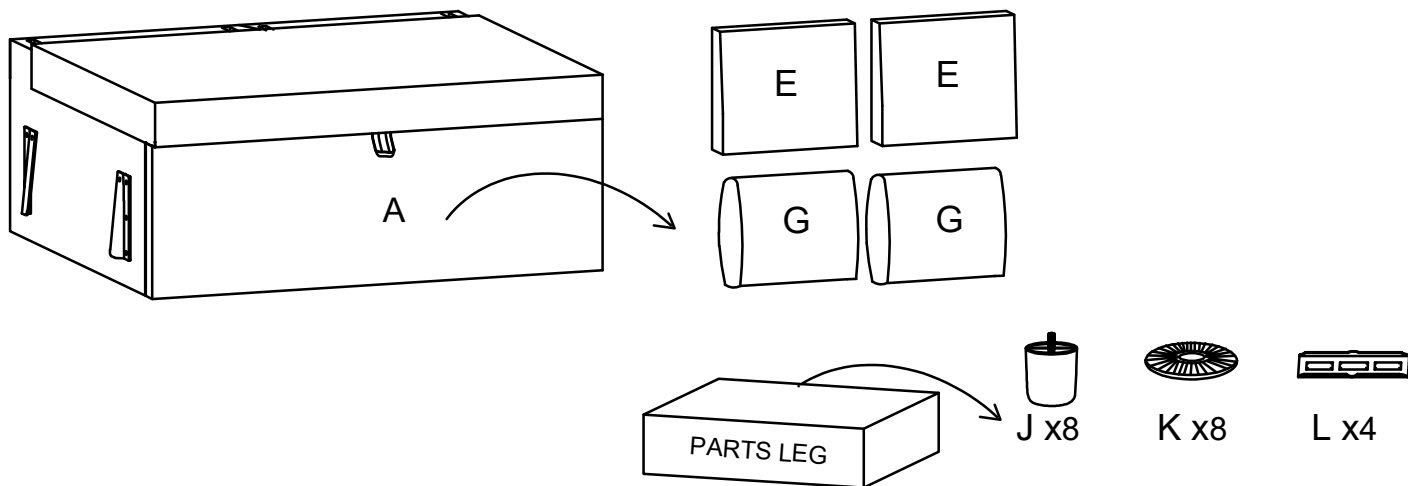

Step 2: Attach the Plastic legs (J)x8 and Washer (K)x8 to the Sofa Frame(A), , and the Arm (C&D) .

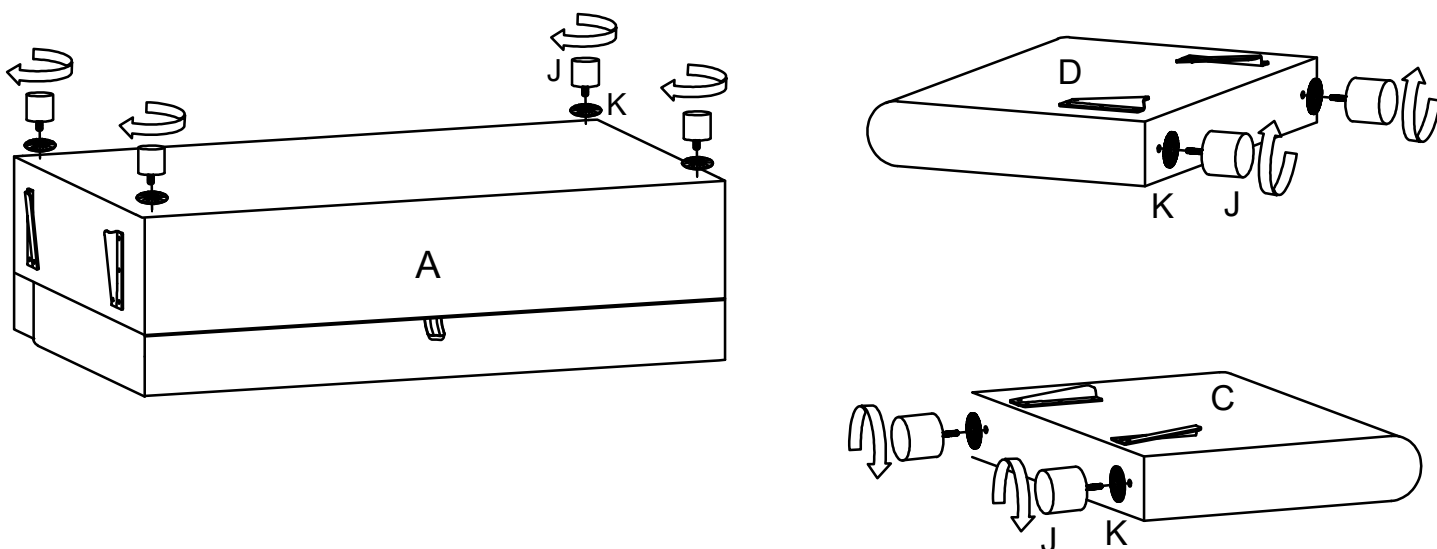

Step 3: Insert the Sofa Frame (A) to the Arm (C). And the Sofa Frame (A) to the Arm (D).

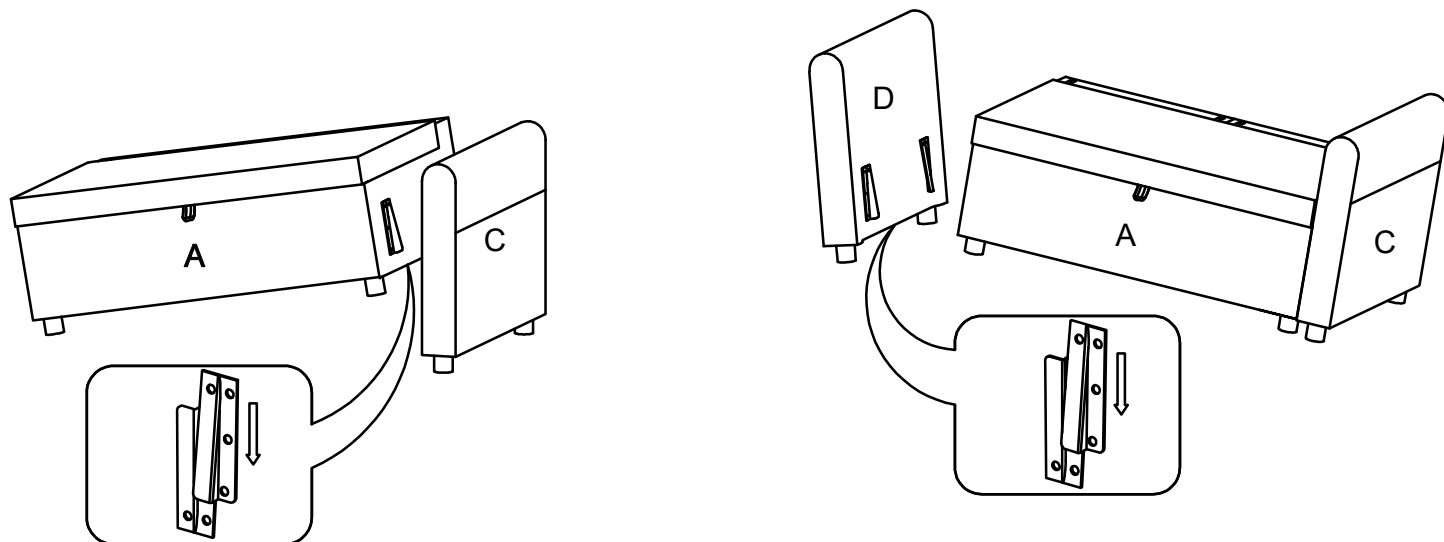

Step 4 : Insert Lock Latches (L) x4 to the Sofa Back (E).

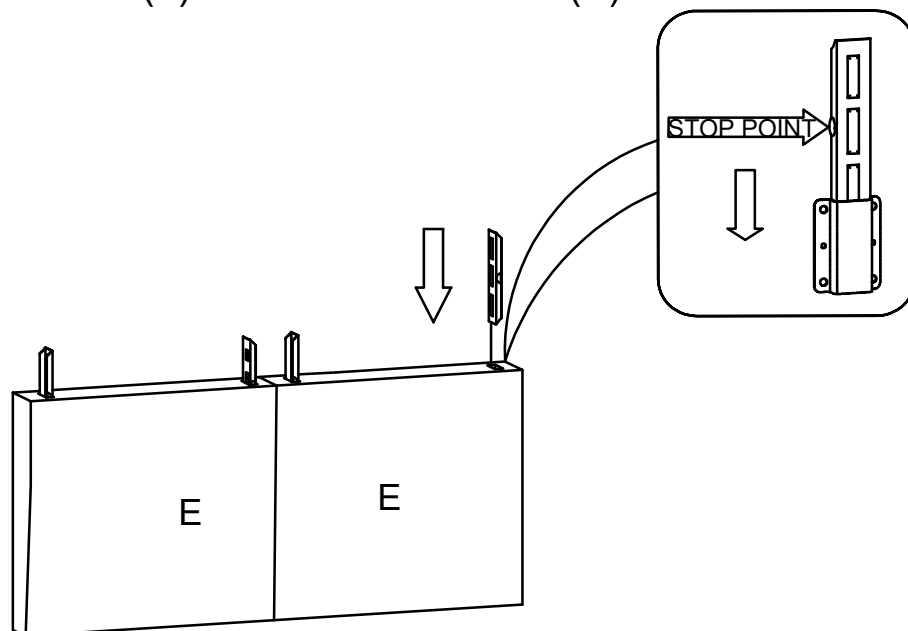

Step 5 : Insert the Chair Back (E) x2 to the Sofa Frame (A).

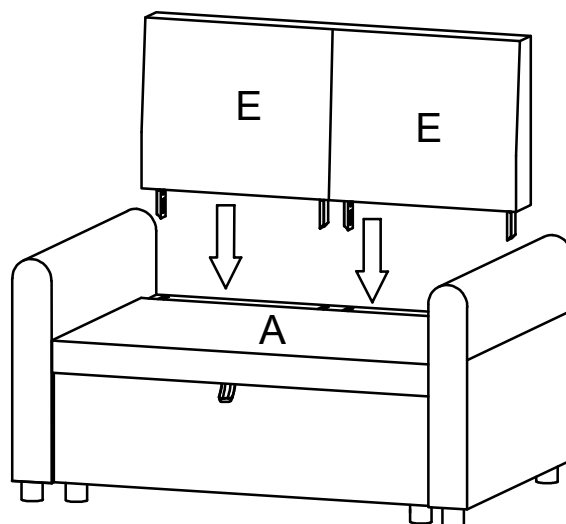

COMPLETED

