

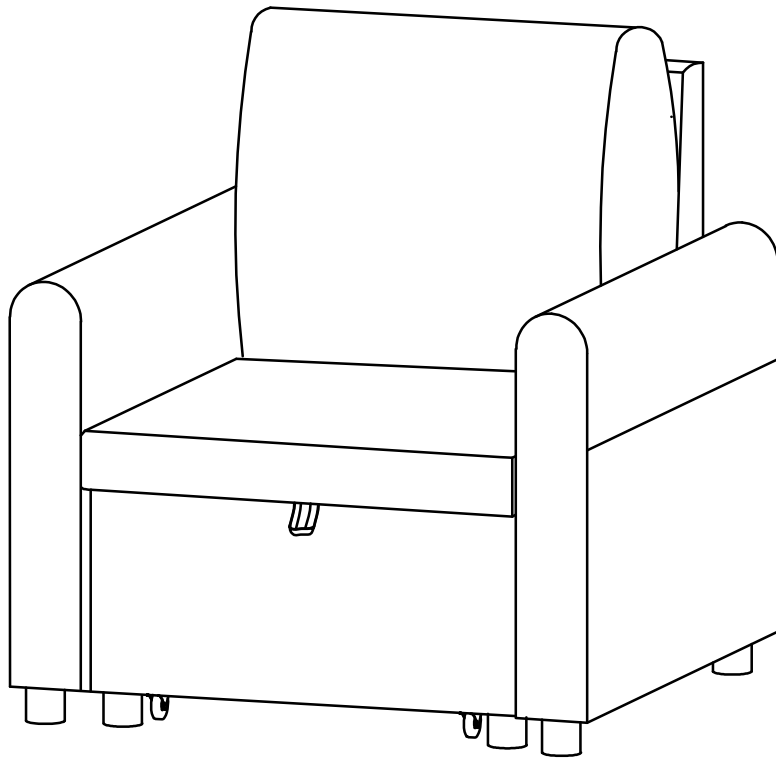









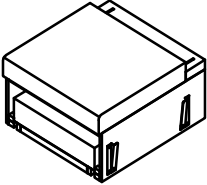
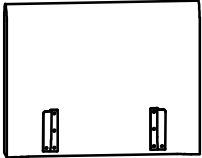
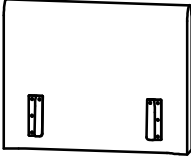
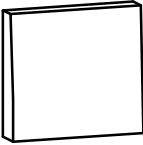

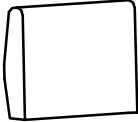
SINGLE CHAIR

ASSEMBLY INSTRUCTIONS

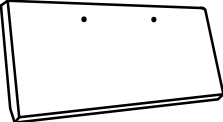

Part No.	Part	Qty	Image	Part No.	Part	Qty	Image
A	Sofa Frame	None		B	Chair Frame	1	
C	Sofa Arm	1		D	Chair Arm	1	
E	Sofa Back	None		F	Chair Back	1	
G	Sofa Back Cushion	None		H	Chair Back Cushion	1	
J	Plastic Leg	8		K	Washer	8	
L	Lock Latches	2		M	Chair Front Fender	1	
N	Allen Bolt	2		O	Allen Washer	2	
P	Allen Wrench	1					

Step 1: Take out the Sofa Back Cushion (H) & Sofa Back (F) & The hardware package from Chair Frame (B), legs & hardware would be found in the hardware package.

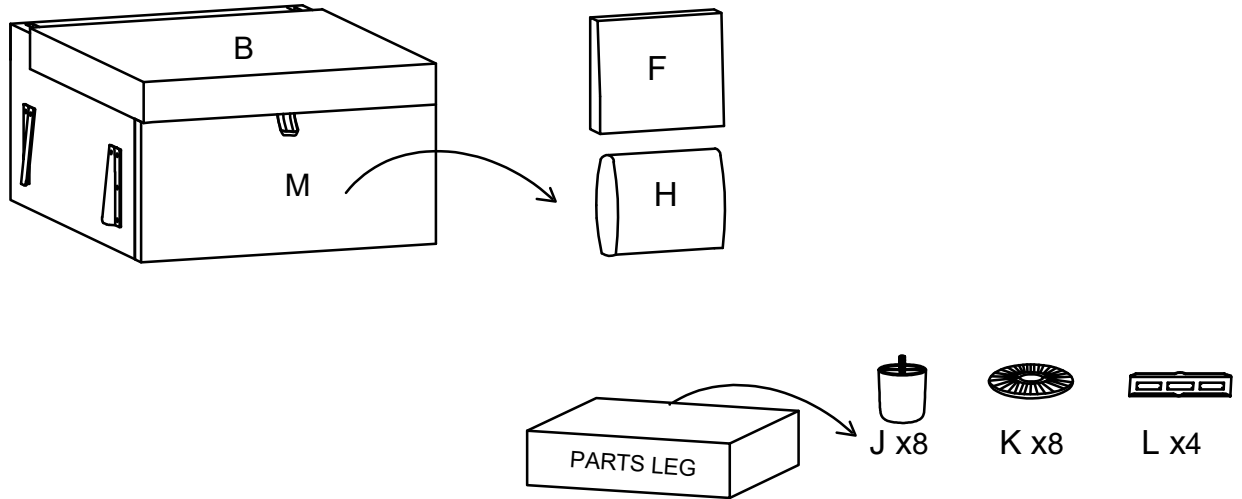

Step 2: Pull part of the bed out, attach Chair Front Fender (M) to Chair Frame (B) with Allen Bolt (N) x 2, and Allen Washer (O) x 2 by using Allen Wrench (P). Attach the Plastic legs (J) x 4 and Washer (K) x 4 to the Chair Frame (B).

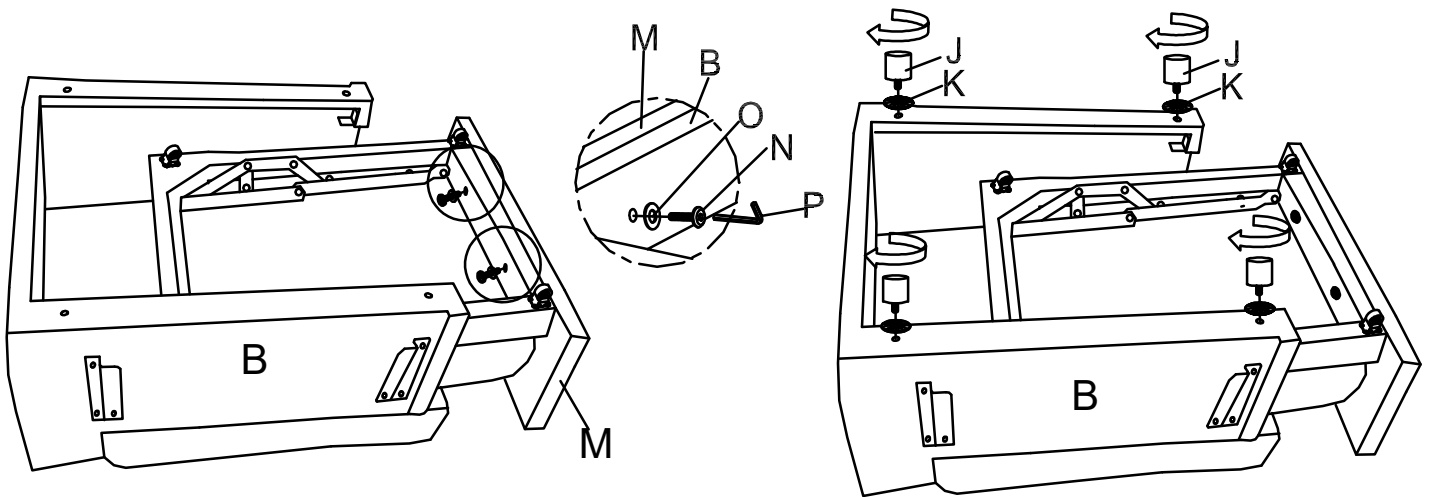

Step 3: Insert the Chair Frame (B) to the Arm (C). And the Chair Frame (B) to the Arm (D).

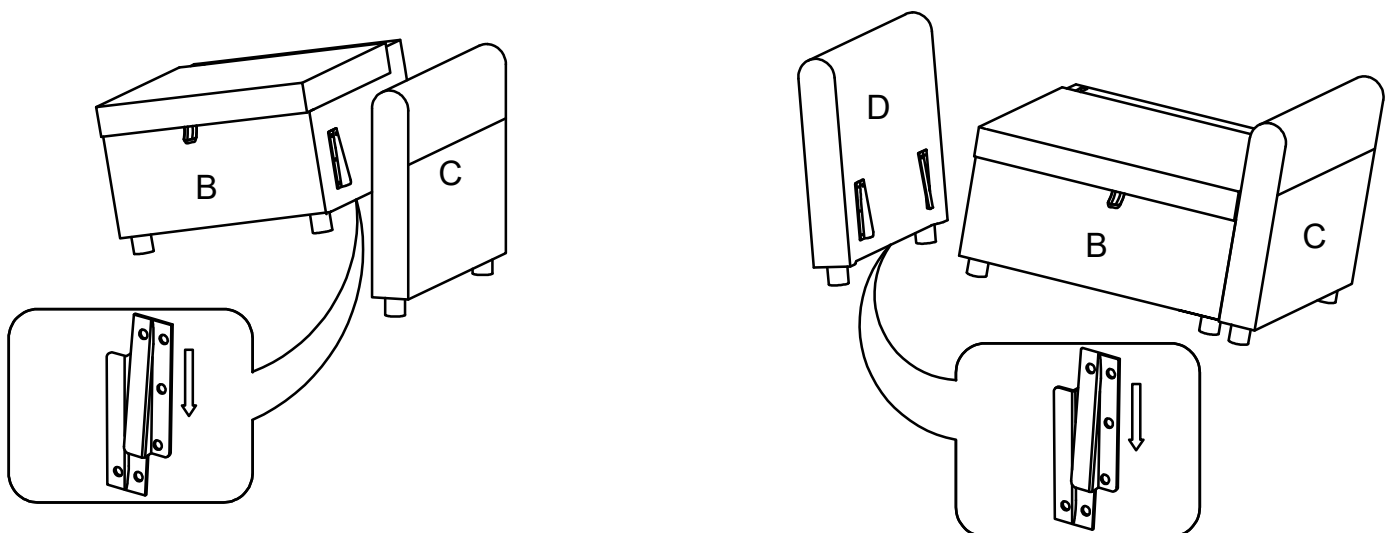

Step 4 : Insert Lock Latches (L) x2 to the Sofa Back (F).

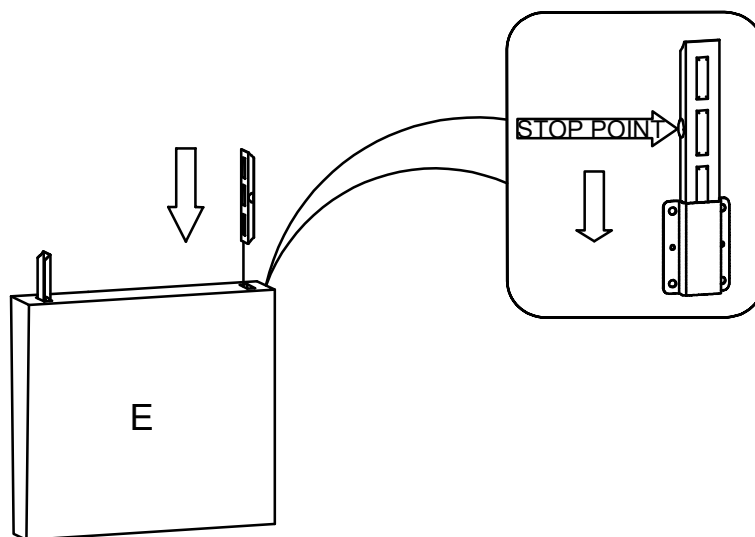

Step 5 : Insert the Chair Back (F) to the Chair Frame(B).

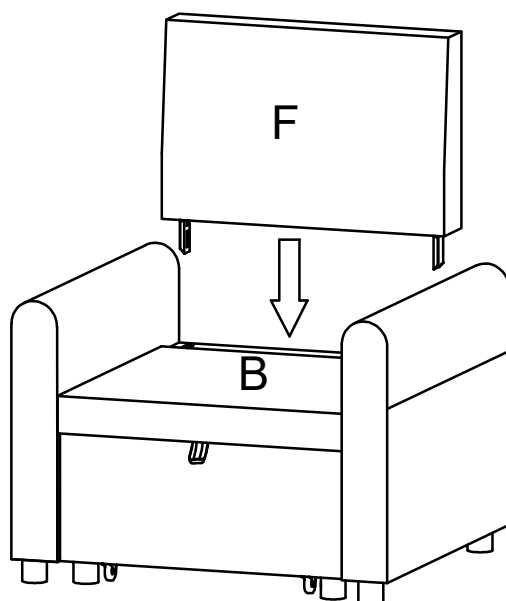

COMPLETED

