

Assembly Instruction

Item No : 96005

Description: 2 Doors Wardrobe



TOOL REQUIRED

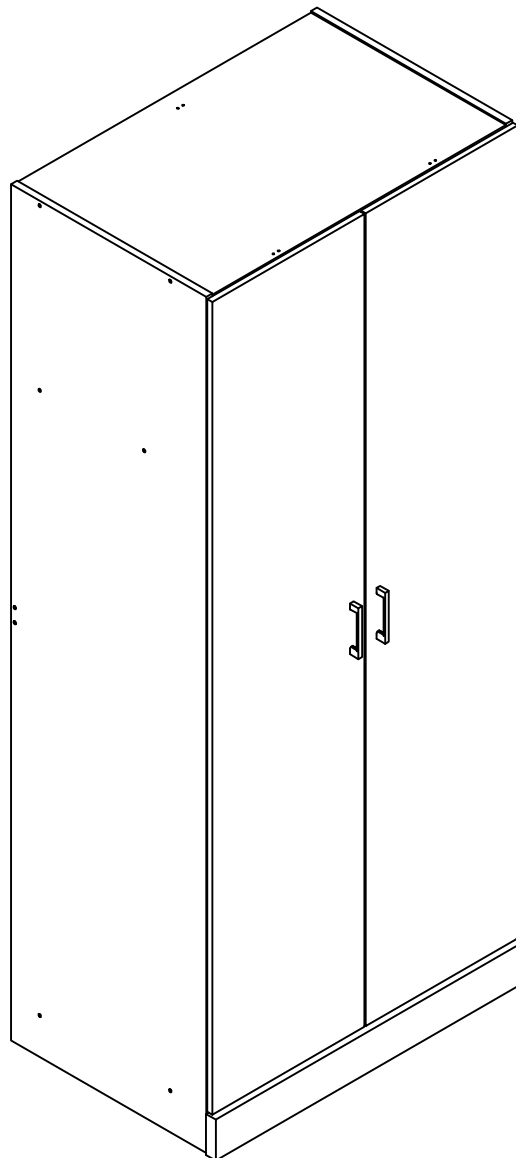
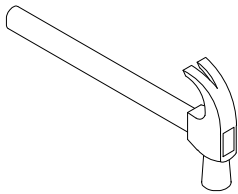
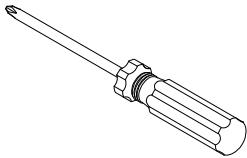

EXPLODED VIEW

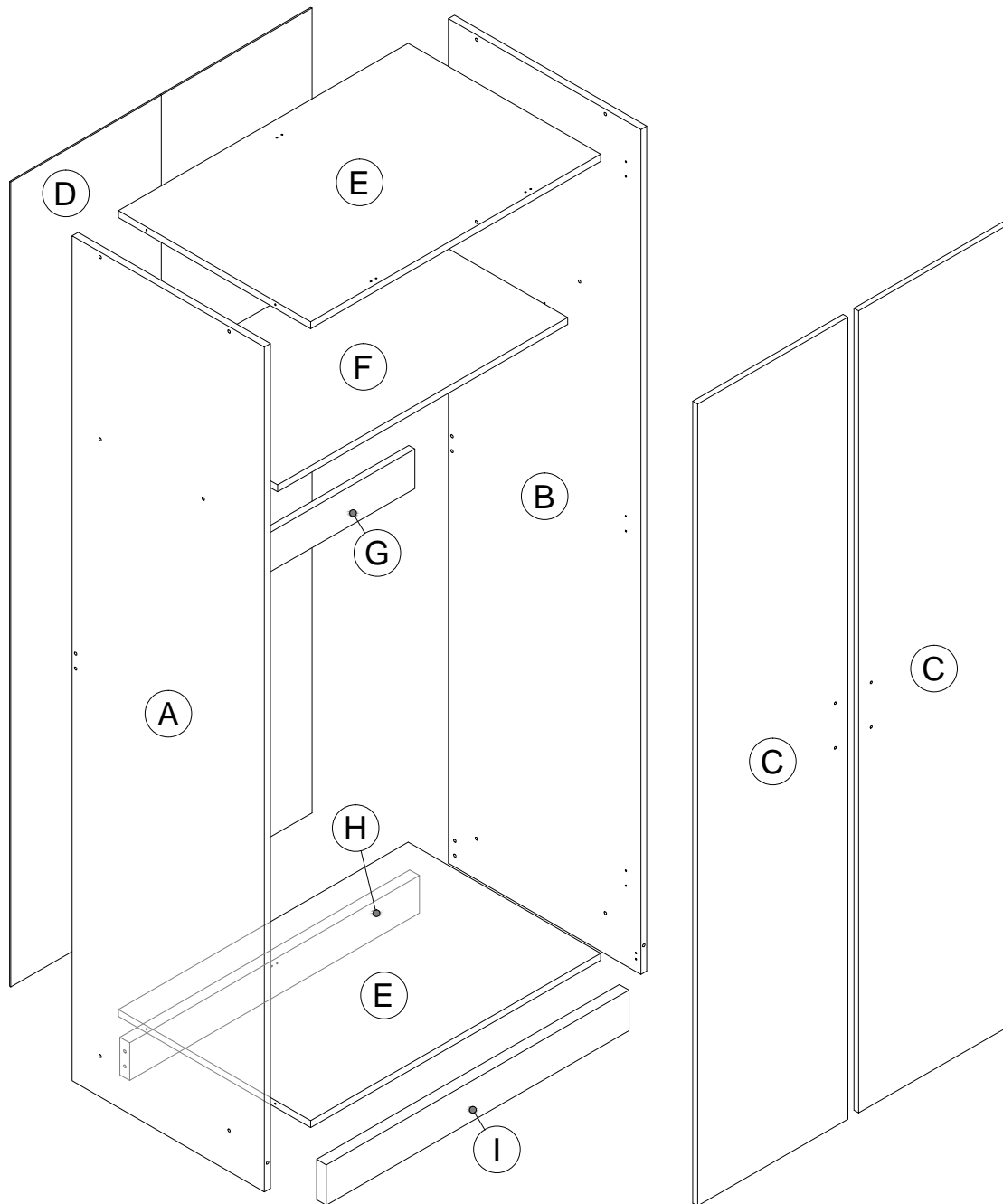

USEFUL HINTS BEFORE YOU START:

1. Read each step carefully before starting.
2. It is important that each step is performed in correct order to avoid difficulties.
3. Identify, soft and count the parts before assembly.
4. Assemble your furniture on packaging cardboard to prevent scratch or damage.
5. Clean the product with mild cleanser using soft damped cloth. Do not use harsh or abrasive cleanser.
6. Using incompatible hardware might cause damage to product.

PARTS LIST

A

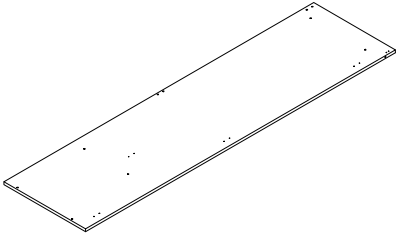

LEFT SIDE PANEL

1 PC

B

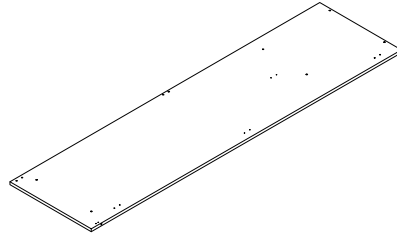

RIGHT SIDE PANEL

1 PC

C

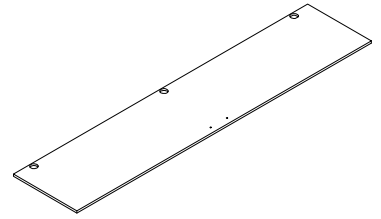

DOOR PANEL

2 PCS

D

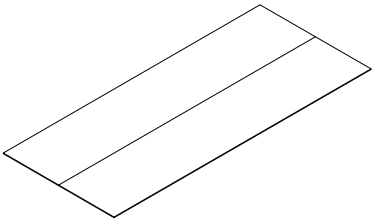

BACK PANEL

1 PC

E

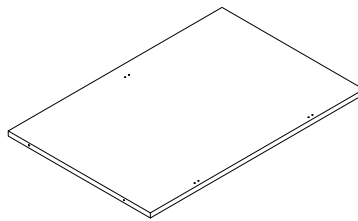

TOP PANEL &
BOTTOM PANEL

2 PCS

F

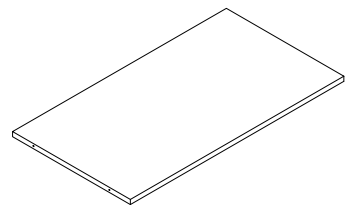

SHELF PANEL

1 PC

G

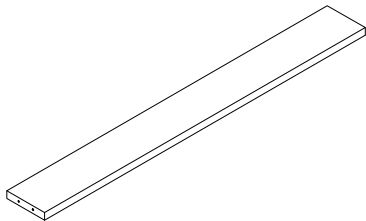

SUPPORT PANEL

1 PC

H

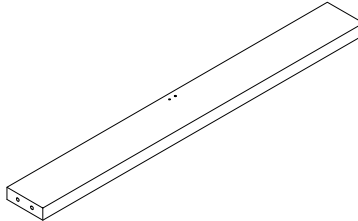

BACK LEG
SUPPORT PANEL

1 PC

I

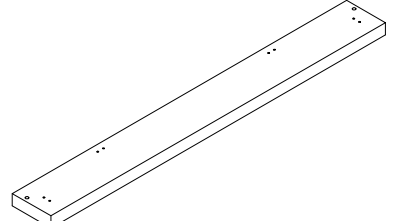

FRONT LEG
SUPPORT PANEL

1 PC

HARDWARE LIST

1

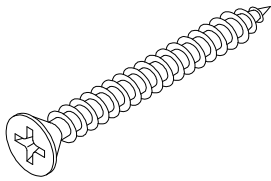

40MM SCREW

16 PCS

2

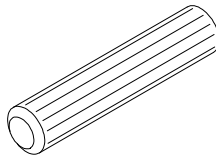

30MM WOOD DOWEL

6 PCS

3

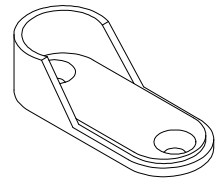

HANGING BRACKET

2 PCS

4

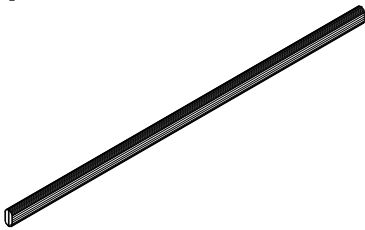

HANGING ROD

1 PC

5

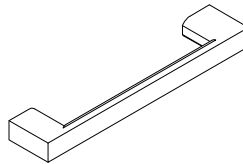

HANDLE

2 PCS

6

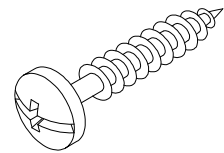

23MM SCREW

4 PCS

7

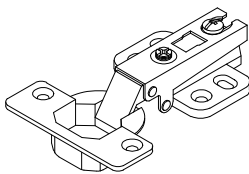

DOOR HINGES

6 PCS

8

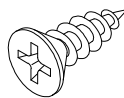

12MM SCREW

48 PCS

9

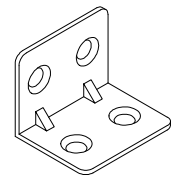

L-BRACKET

5 PCS

10

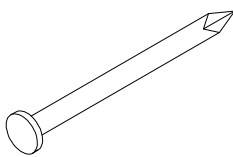

NAIL

52 PCS

11

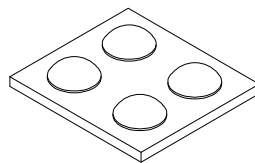

BUMPER PARECHOC

4 PCS

12

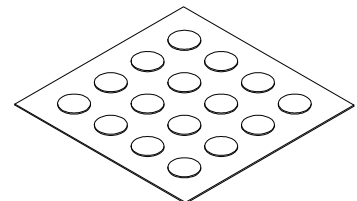

STICKER

16 PCS

HARDWARE LIST

96

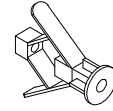
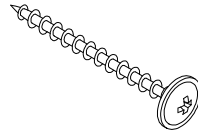
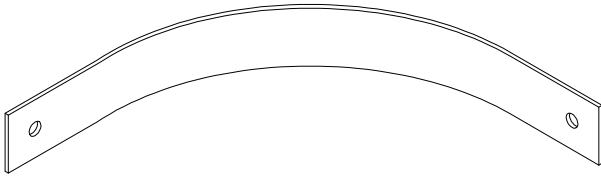

WALL MOUNT SET

1 PC

A

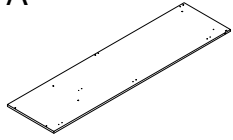

LEFT SIDE PANEL 1 PC

3



HANGING BRACKET 1 PC

8



12MM SCREW 2 PCS

STEP 1

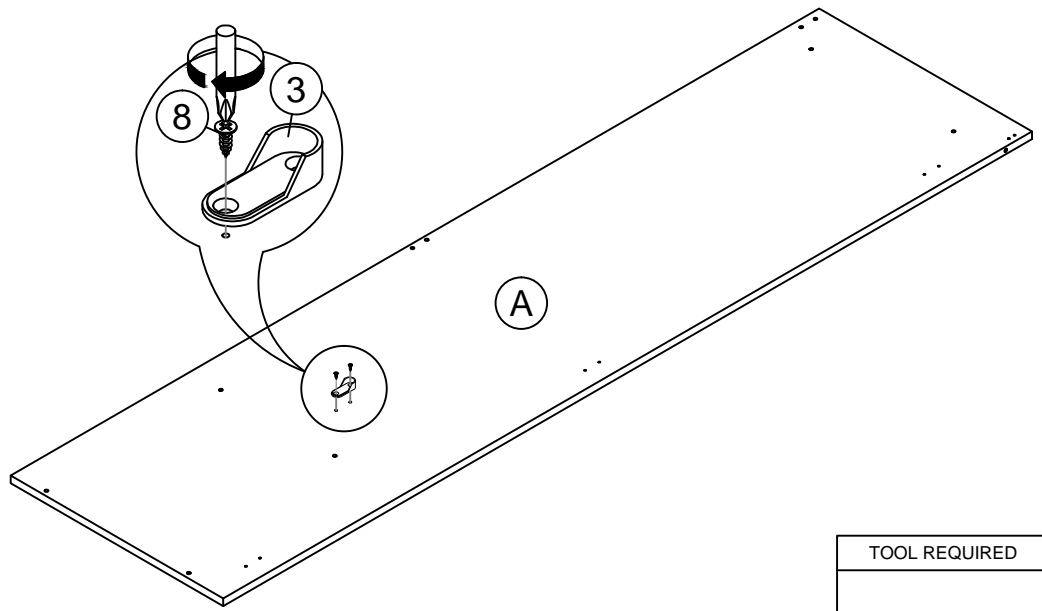

TOOL REQUIRED

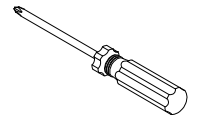

B

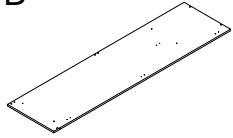

RIGHT SIDE PANEL 1 PC

3



HANGING BRACKET 1 PC

8



12MM SCREW 2 PCS

STEP 2

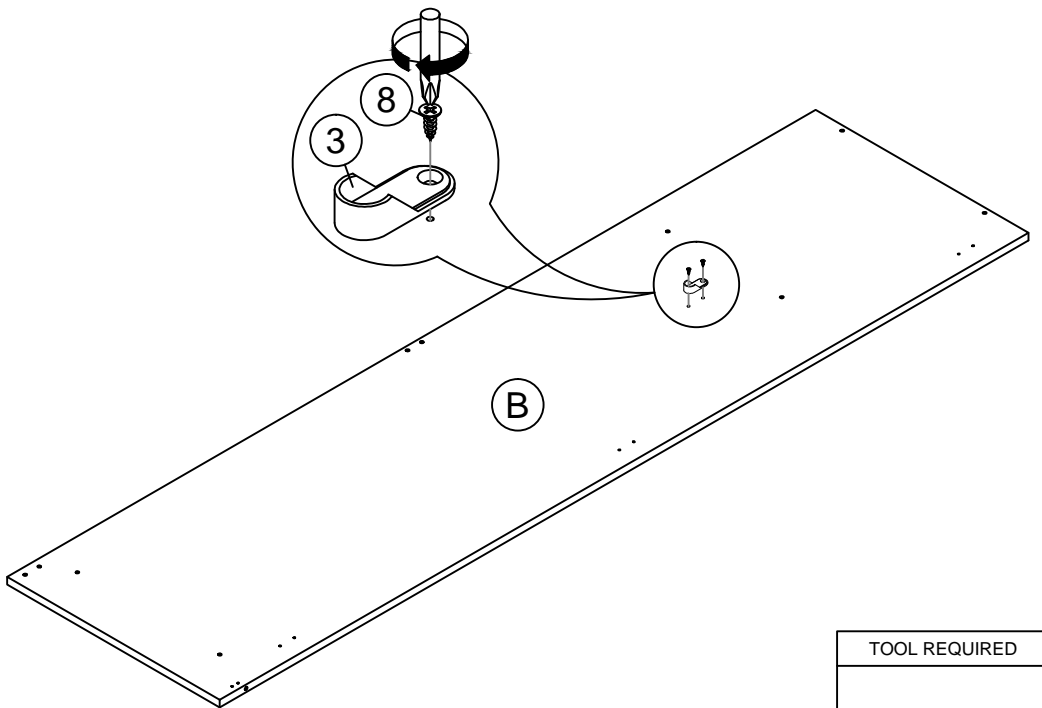

TOOL REQUIRED

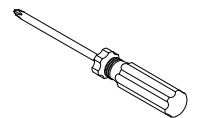

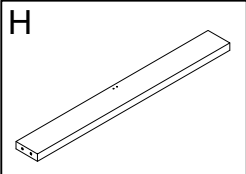

BACK LEG SUPPORT PANEL 1 PC

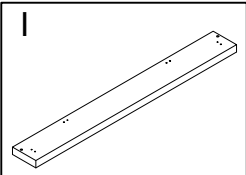

FRONT LEG SUPPORT PANEL 1 PC

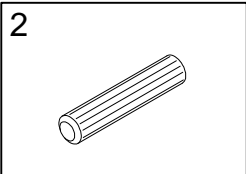

30MM WOOD DOWEL 4 PCS

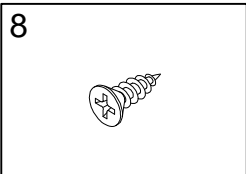

12MM SCREW 10 PCS

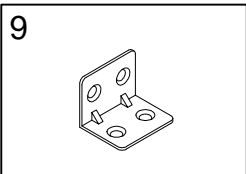

L-BRACKET 5 PCS

STEP 3

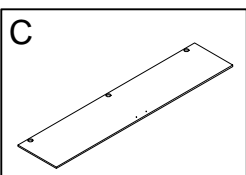
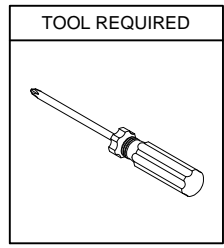
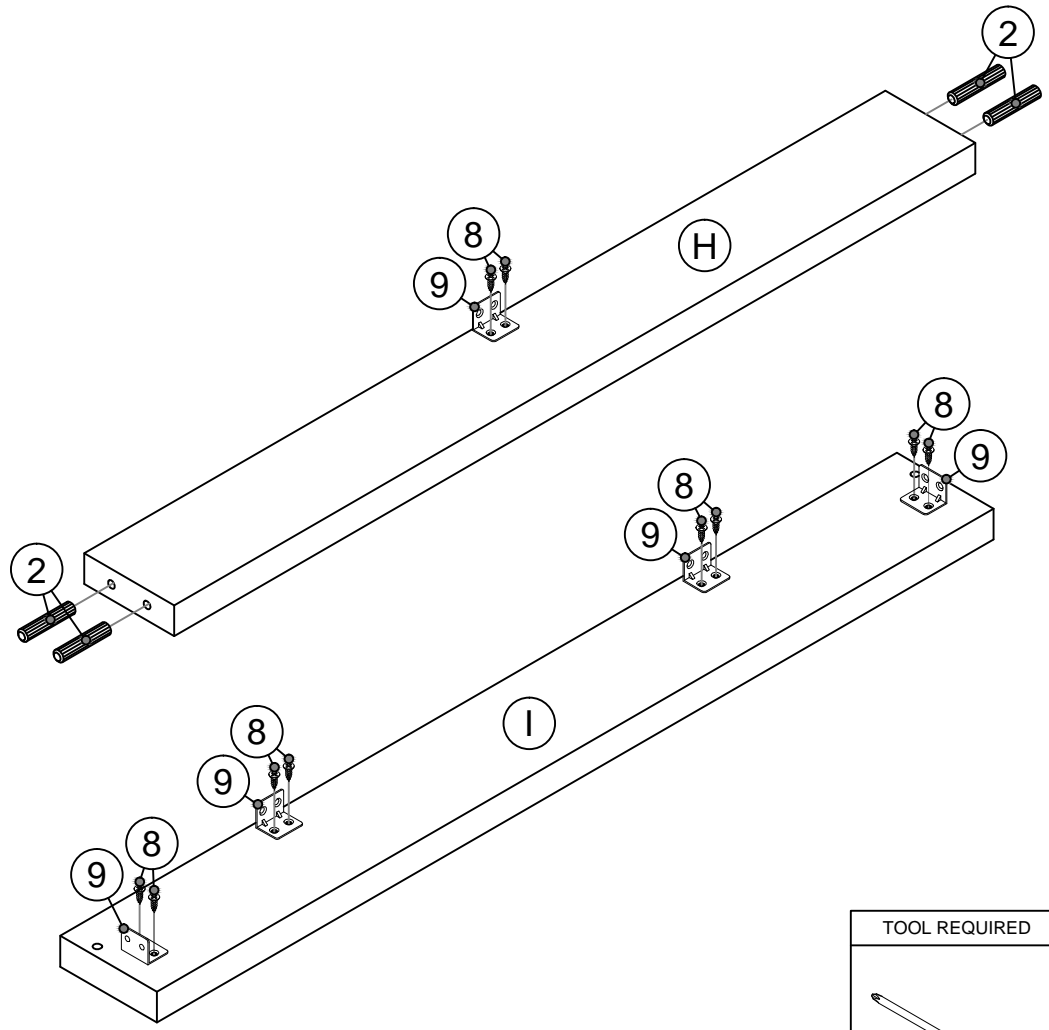

DOOR PANEL 2 PCS

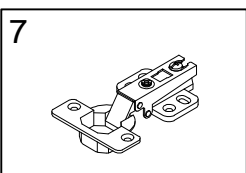

DOOR HINGES 6 PCS

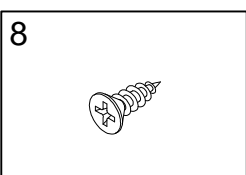

12MM SCREW 12 PCS

STEP 4

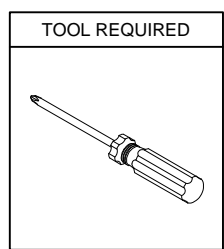
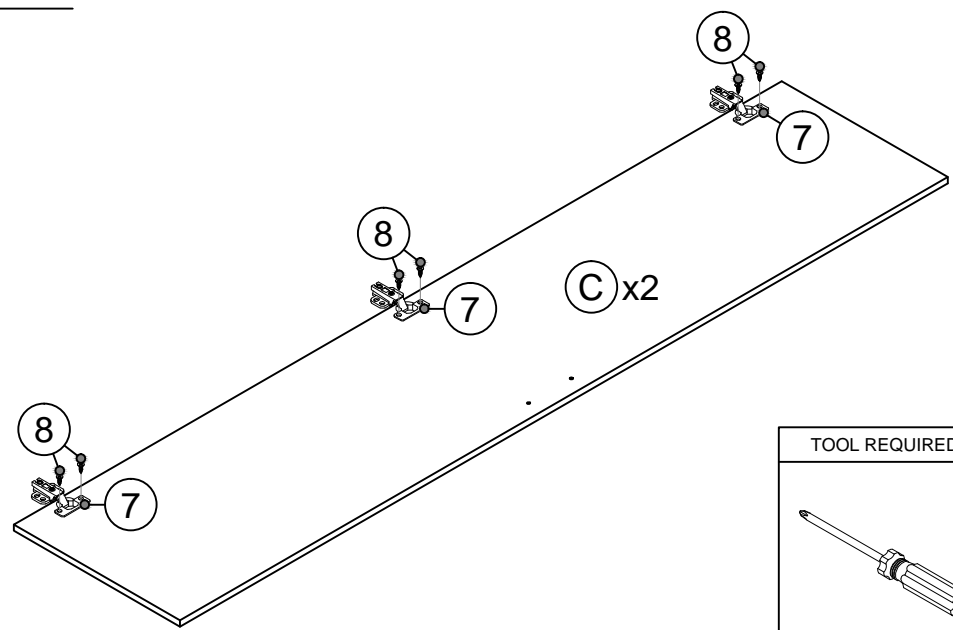

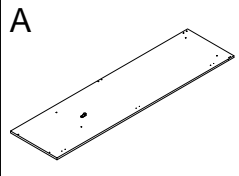

LEFT SIDE PANEL | 1 PC

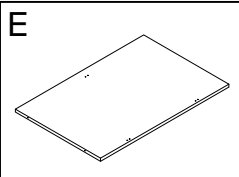

TOP PANEL & BOTTOM PANEL | 2 PCS

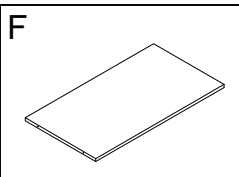

SHELF PANEL | 1 PC

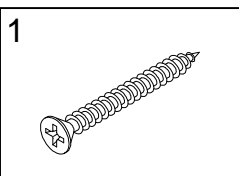

40MM SCREW | 6 PCS

STEP 5

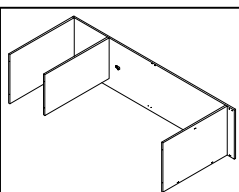
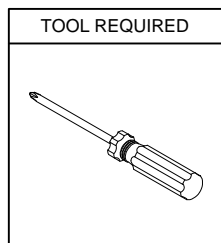
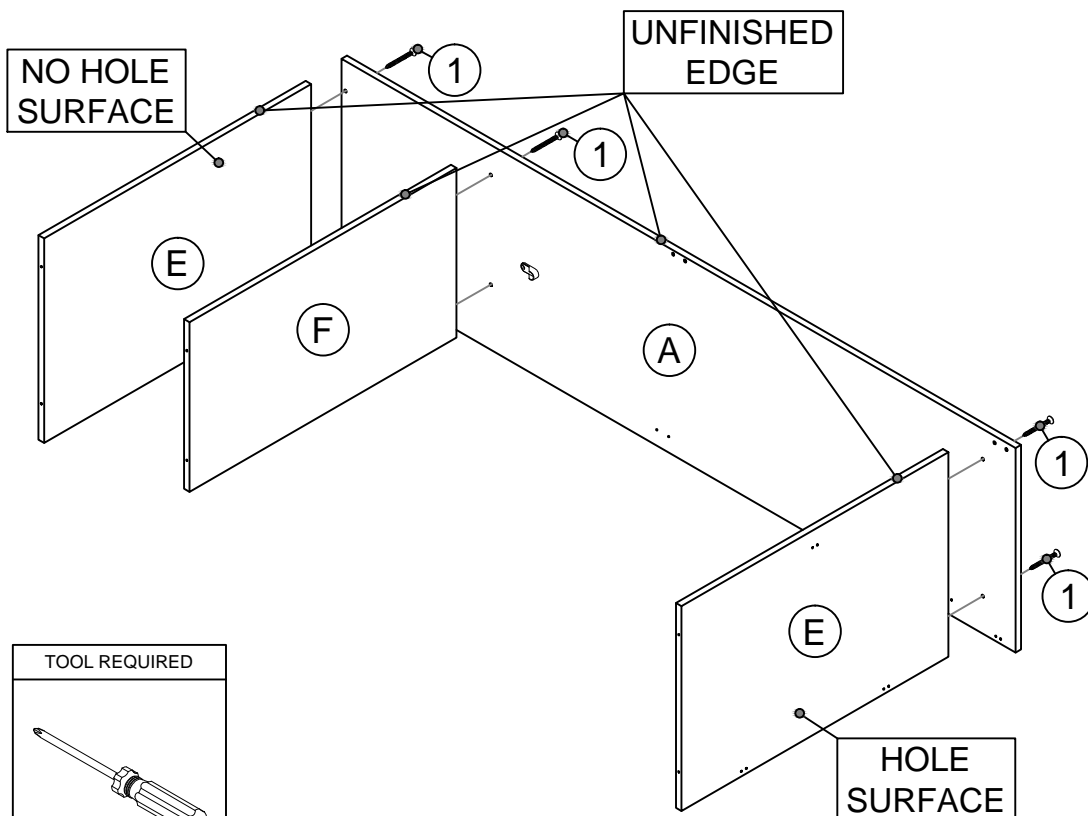

ASSEMBLED UNIT

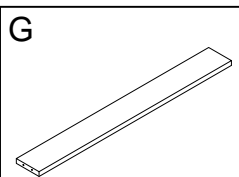

SUPPORT PANEL | 1 PC

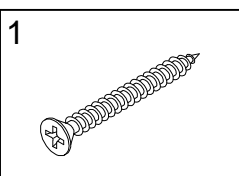

40MM SCREW | 2 PCS

STEP 6

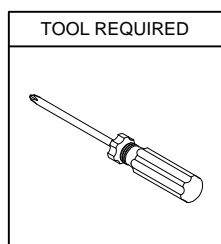
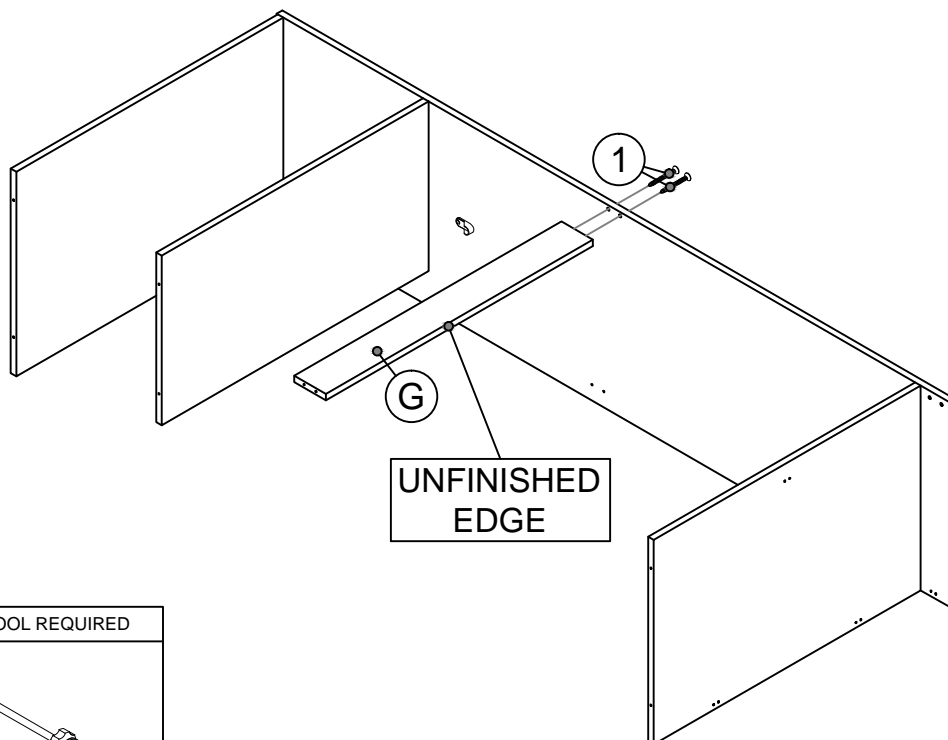

STEP 7

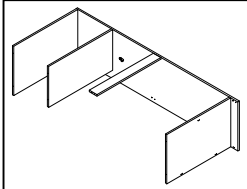

ASSEMBLED UNIT

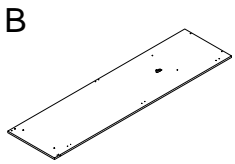

RIGHT SIDE PANEL 1 PC

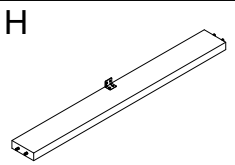

BACK LEG SUPPORT PANEL 1 PC

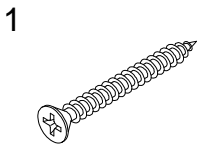

40MM SCREW 8 PCS

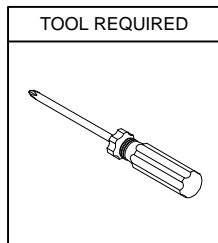
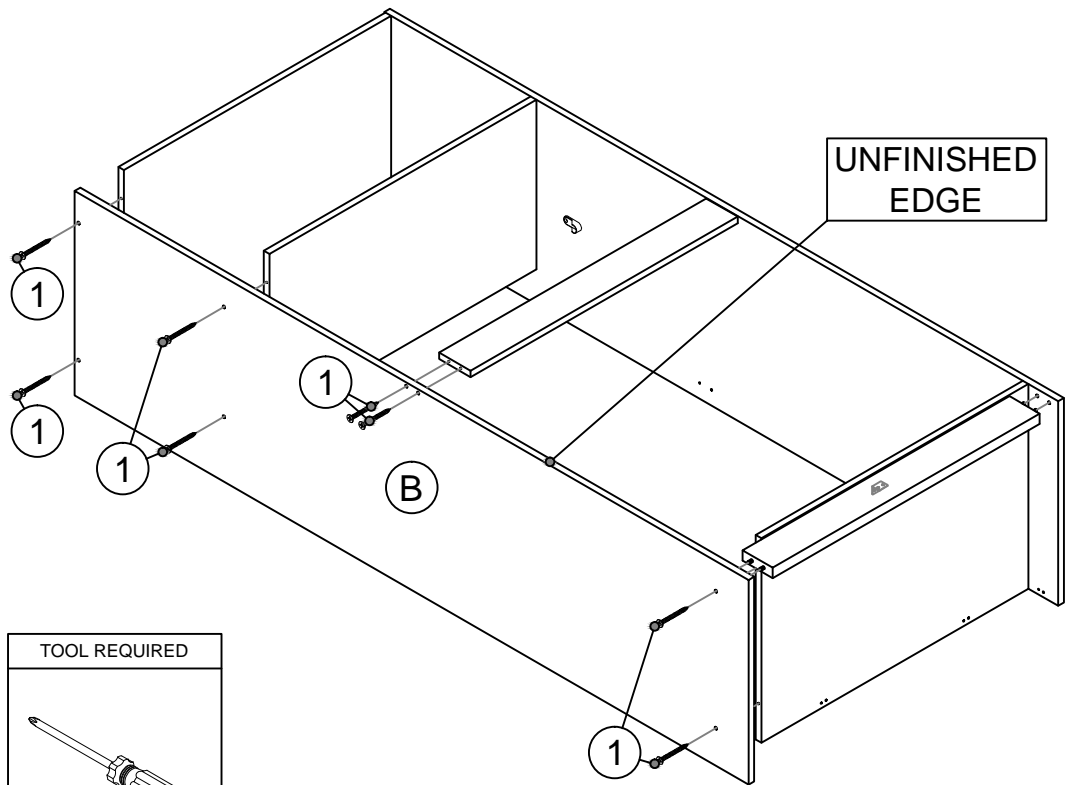

TOOL REQUIRED

STEP 8

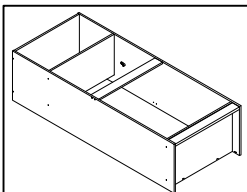

ASSEMBLED UNIT

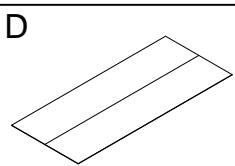

BACK PANEL 1 PC

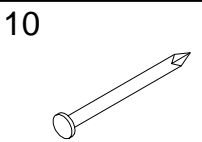

NAIL 52 PCS

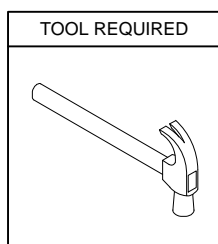
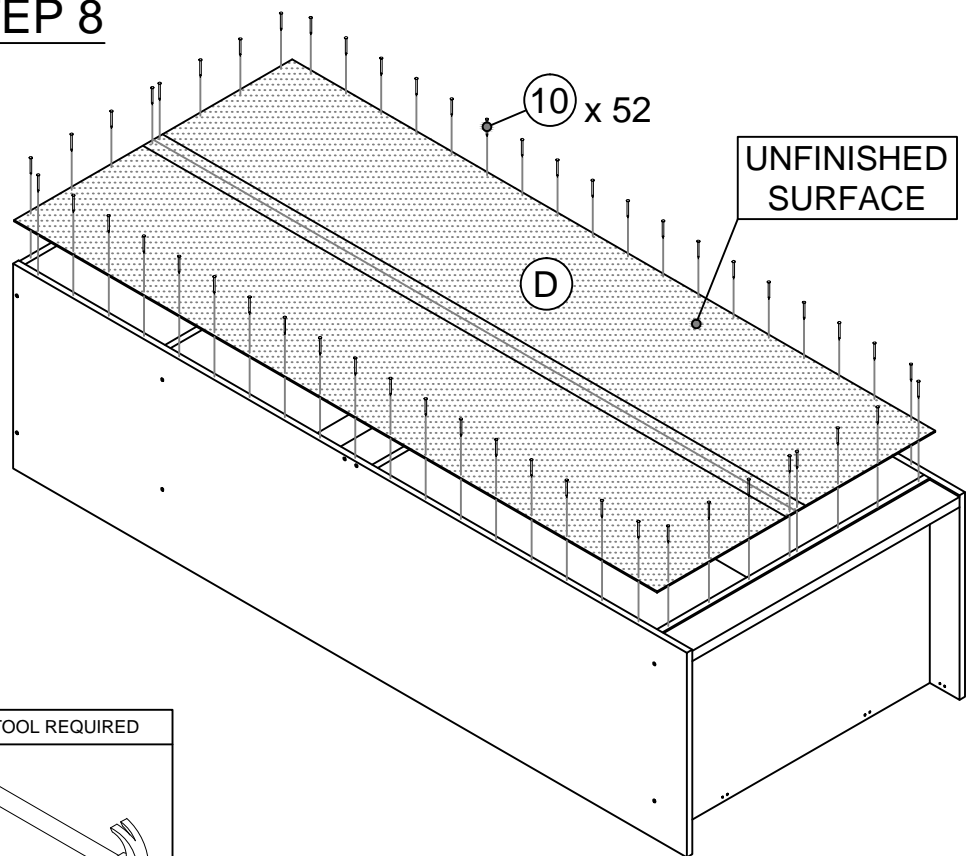

TOOL REQUIRED

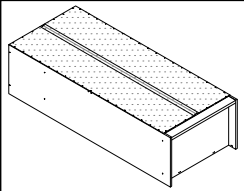

ASSEMBLED UNIT

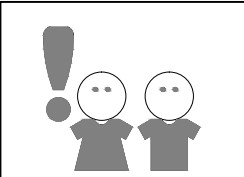

HELPER

STEP 9

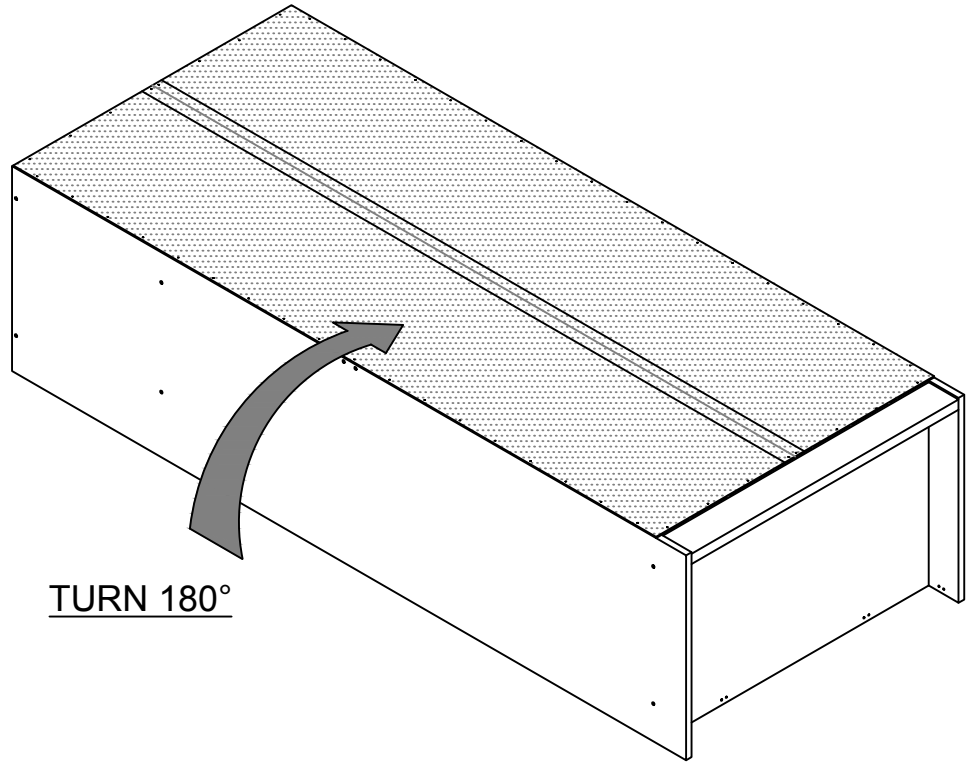

TURN 180°

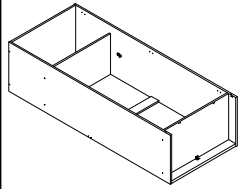

ASSEMBLED UNIT

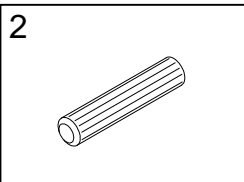

30MM WOOD DOWEL | 2 PCS

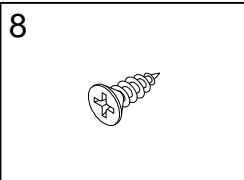

12MM SCREW | 2 PCS

STEP 10

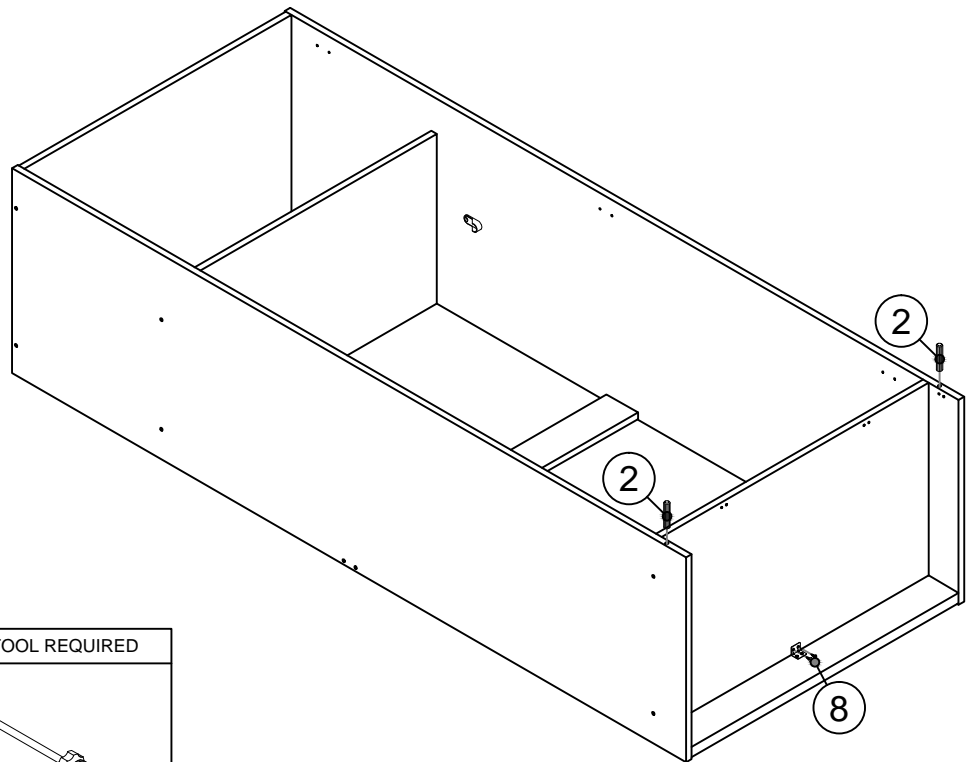

TOOL REQUIRED

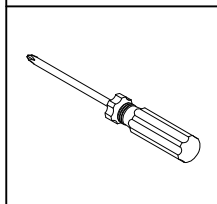

STEP 11

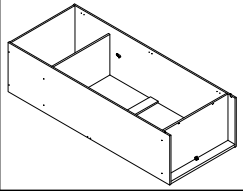

ASSEMBLED UNIT

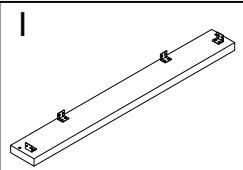

FRONT LEG
SUPPORT PANEL 1 PC

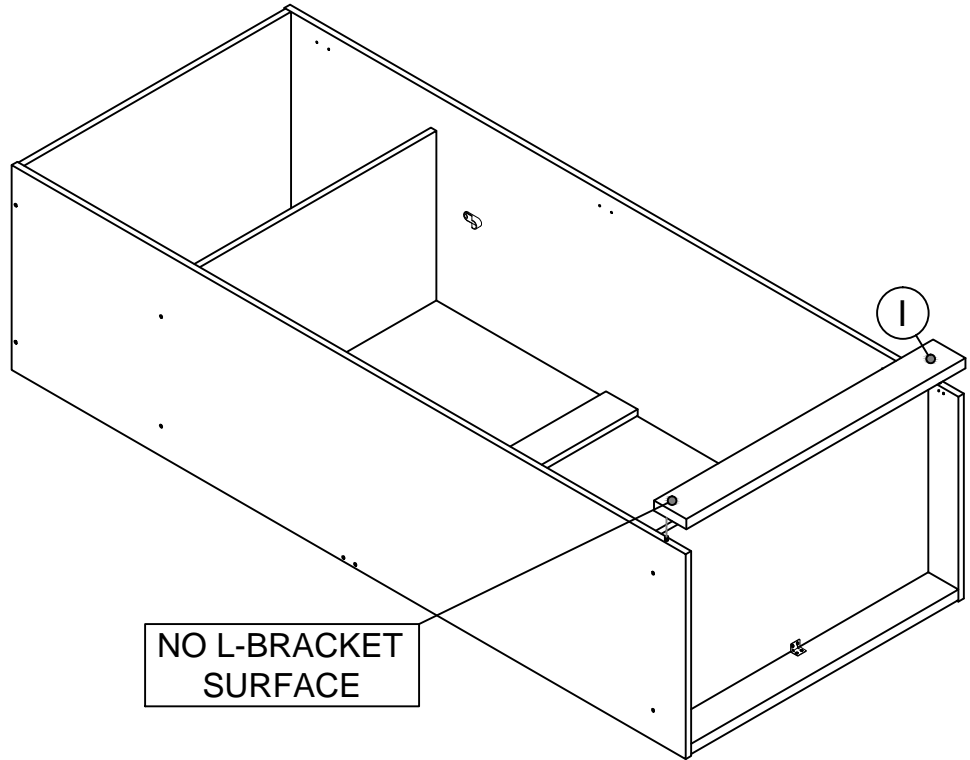

STEP 12

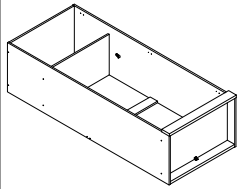

ASSEMBLED UNIT

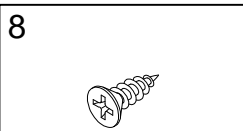

12MM SCREW 8 PCS

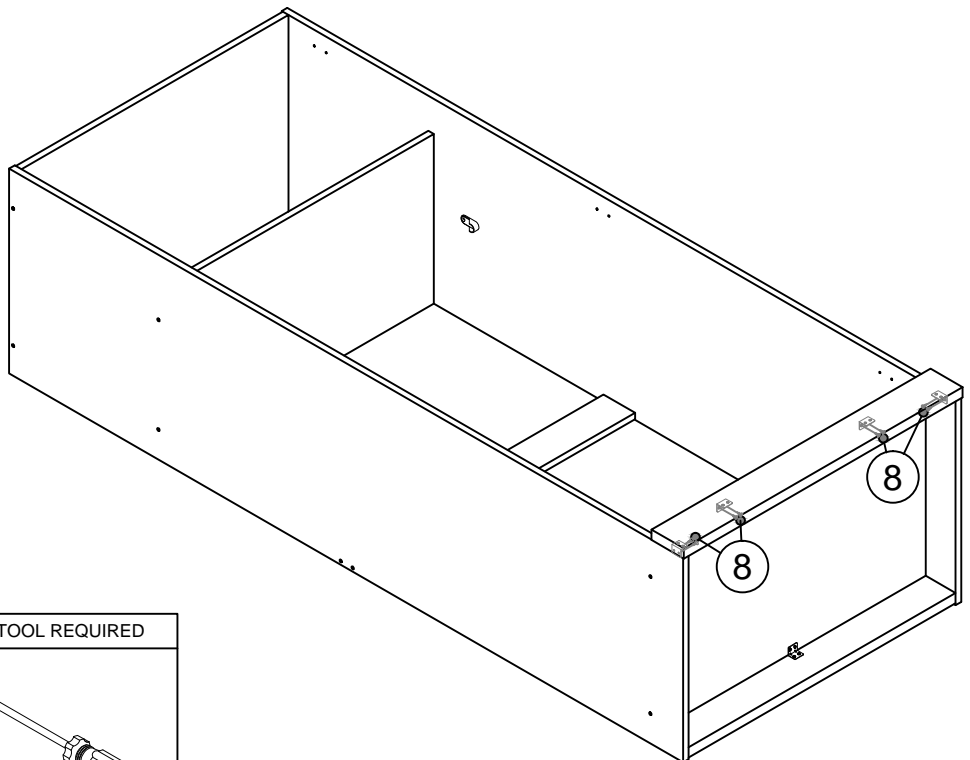

TOOL REQUIRED

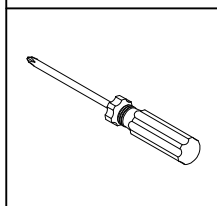

STEP 13

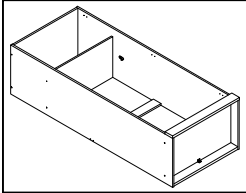

ASSEMBLED UNIT

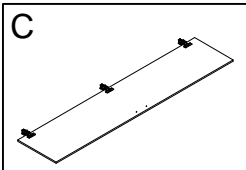

DOOR PANEL 2 PCS

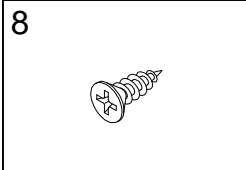

12MM SCREW 12 PCS

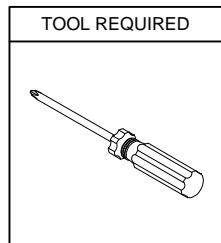

TOOL REQUIRED

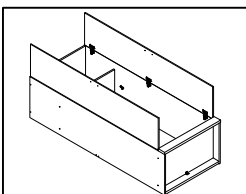
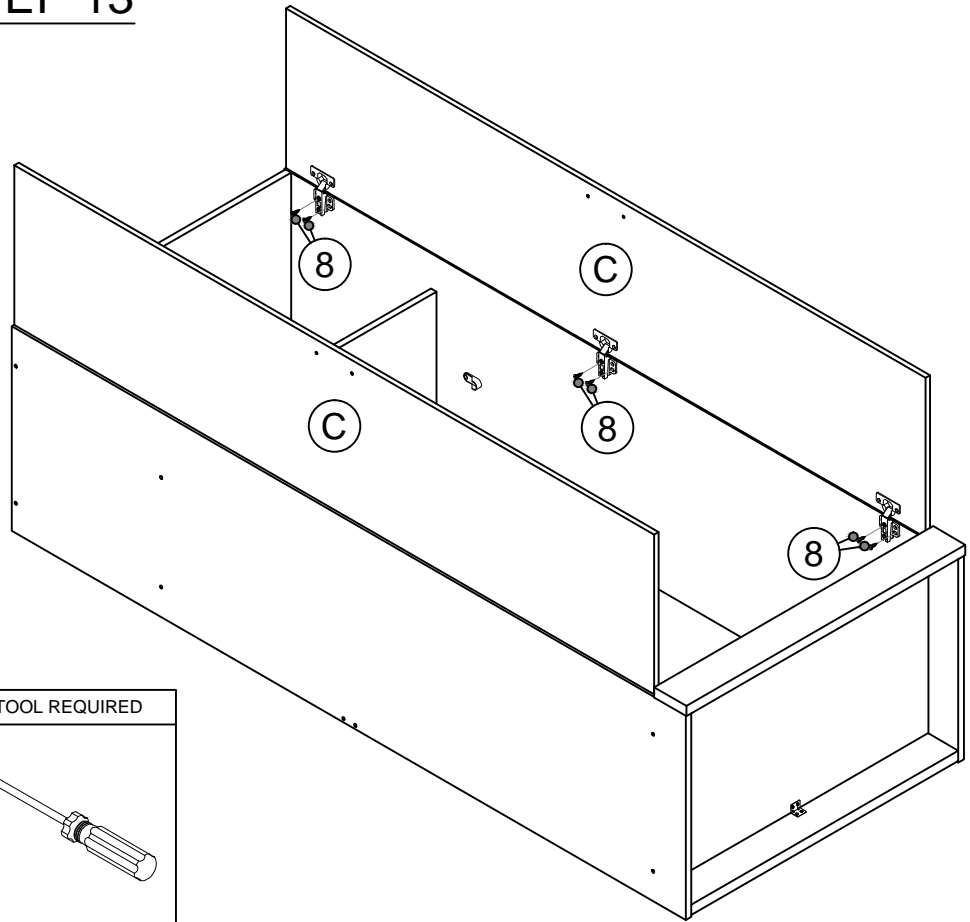

ASSEMBLED UNIT

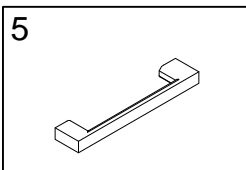

HANDLE 2 PCS

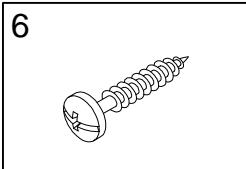

23MM SCREW 4 PCS

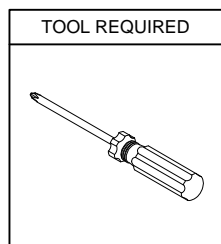

TOOL REQUIRED

STEP 14

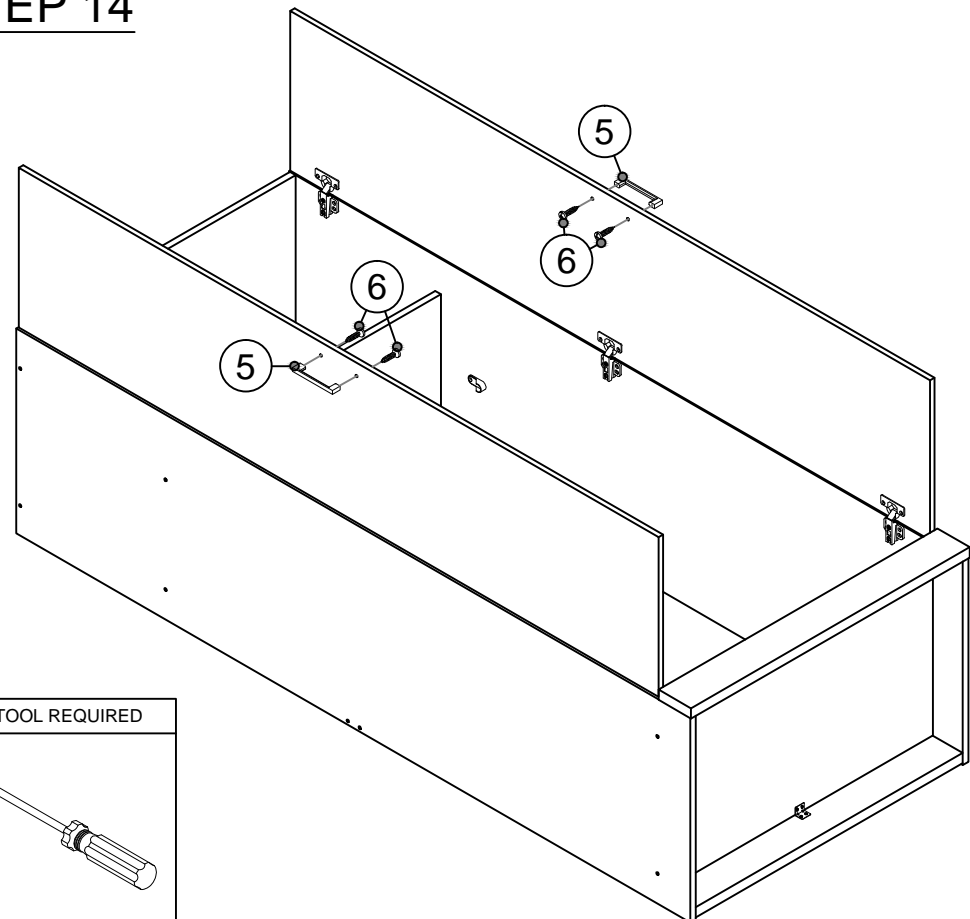

STEP 15

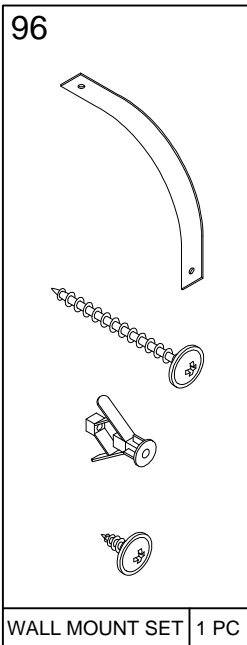
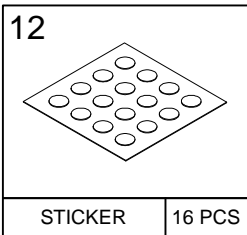
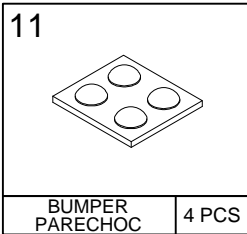
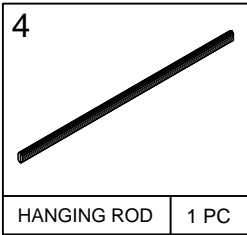
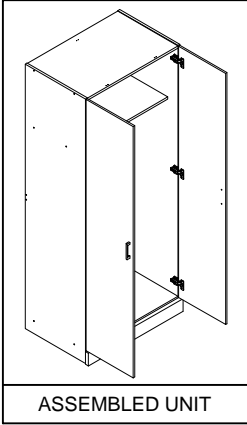

(vertical adjustment)

Adjusting Screw
(Horizontal)

Mounting Screw
(Depth)

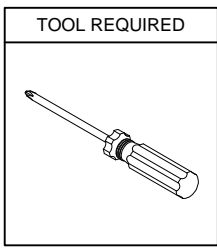
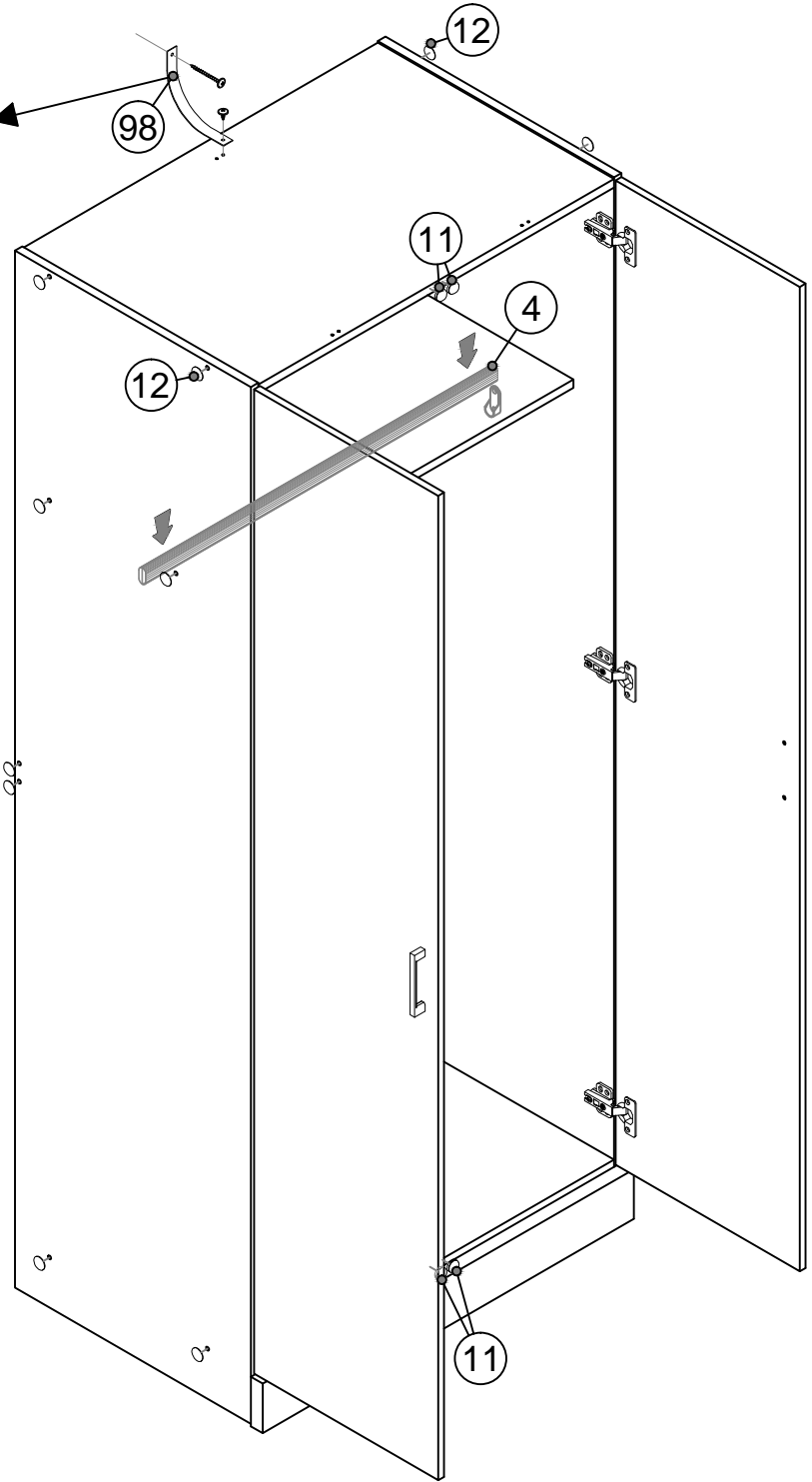
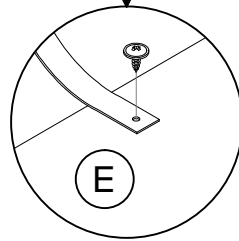
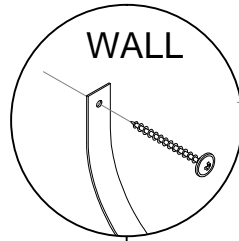
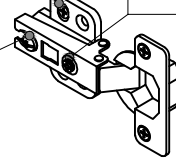

STEP 16

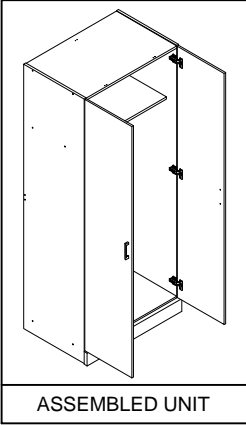

(vertical adjustment)

Adjusting Screw
(Horizontal)

Mounting Screw
(Depth)

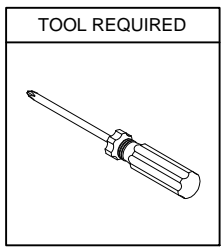
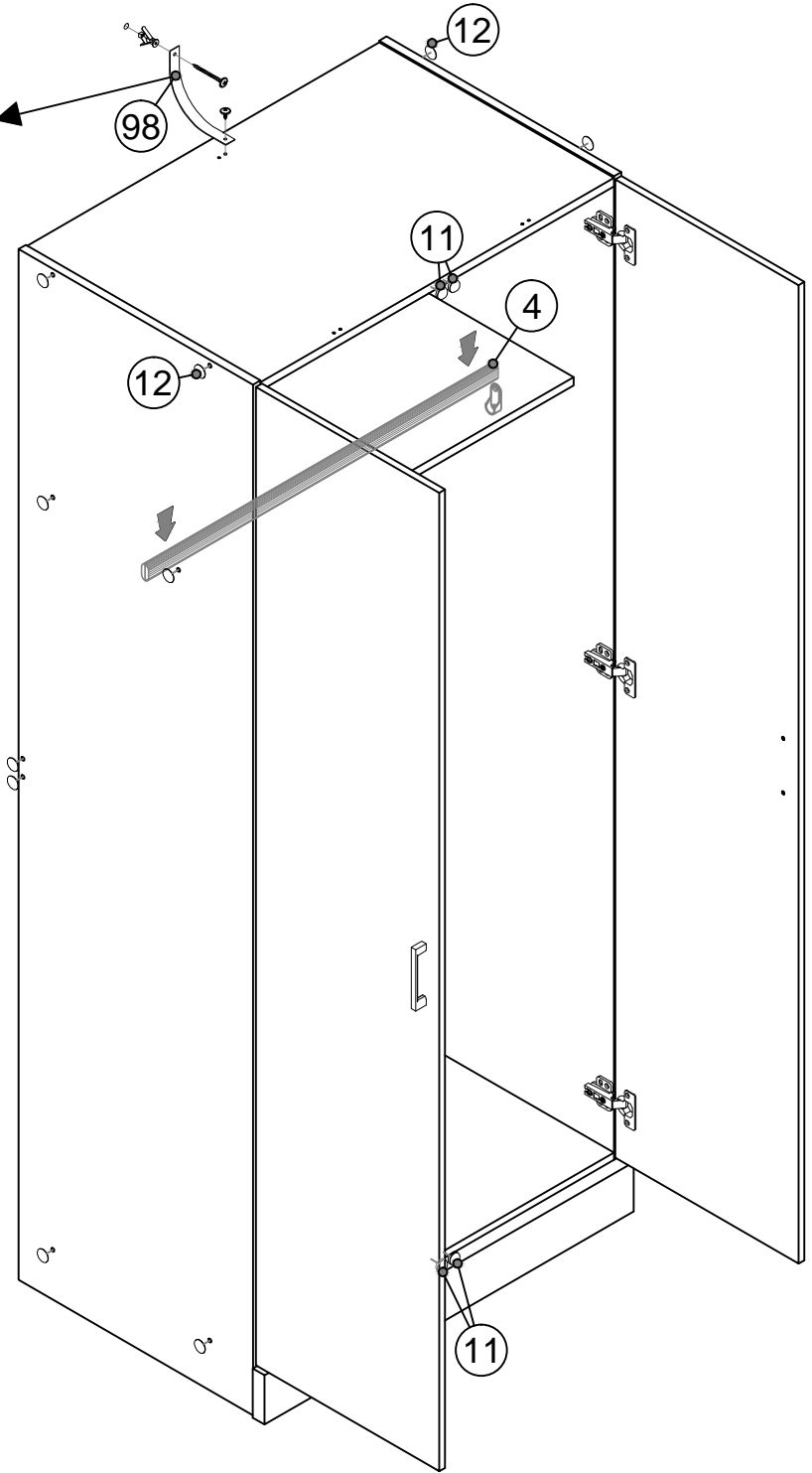
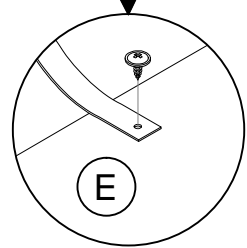
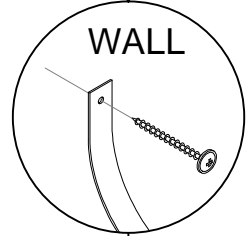
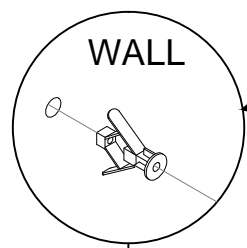
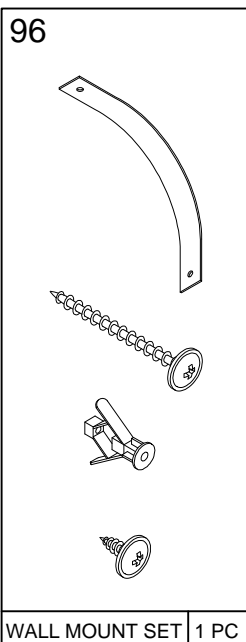
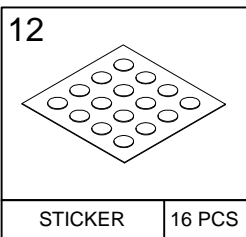
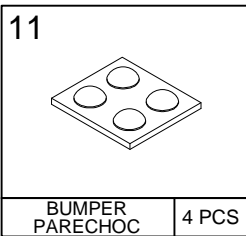
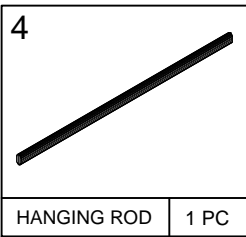
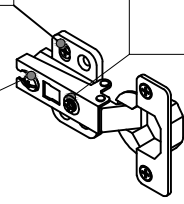

Recommended Maximum Weight

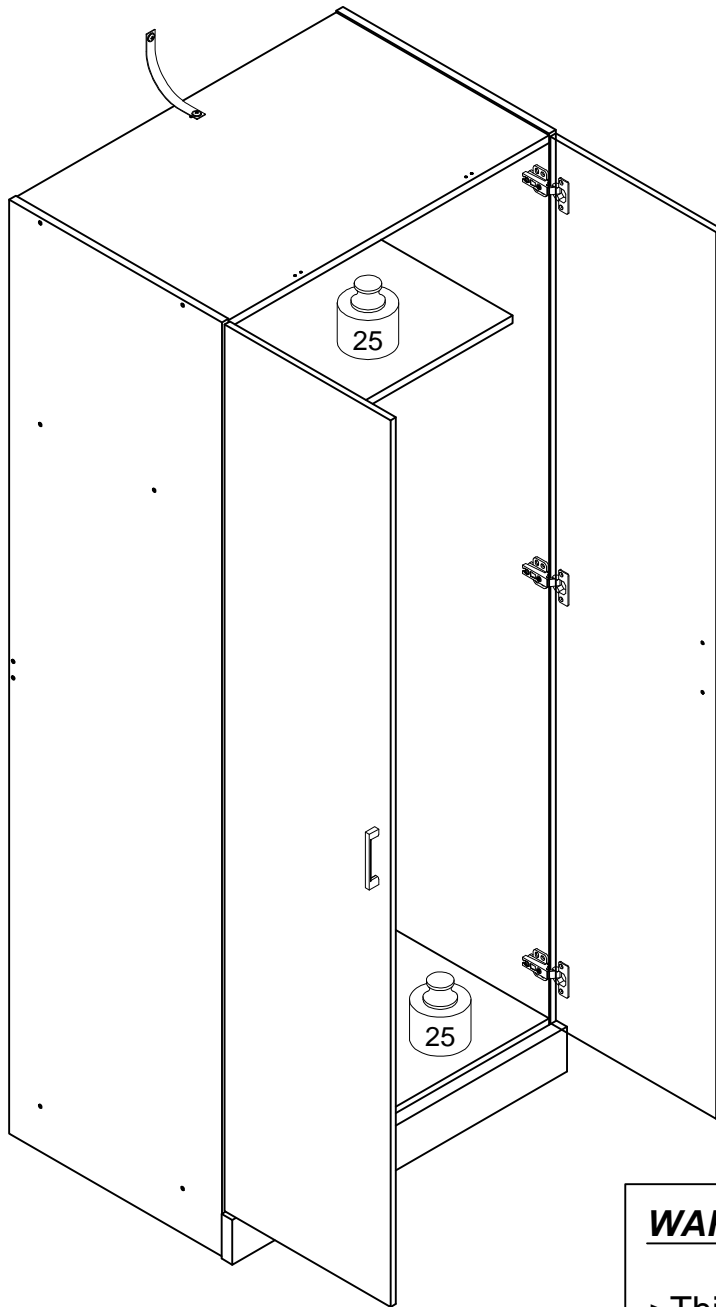

*Unit in Pound(lbs.)

WARNING:

- >This unit has been designed to support the maximum loads shown. Exceeding these load limits could cause sagging, instability, product collapse, and/or serious injury.
- >DO NOT allow children to climb on unit.
- > Put heavier items on lower shelves.