

OPERATION MANUAL

COFFEE TABLE

Model : 97029

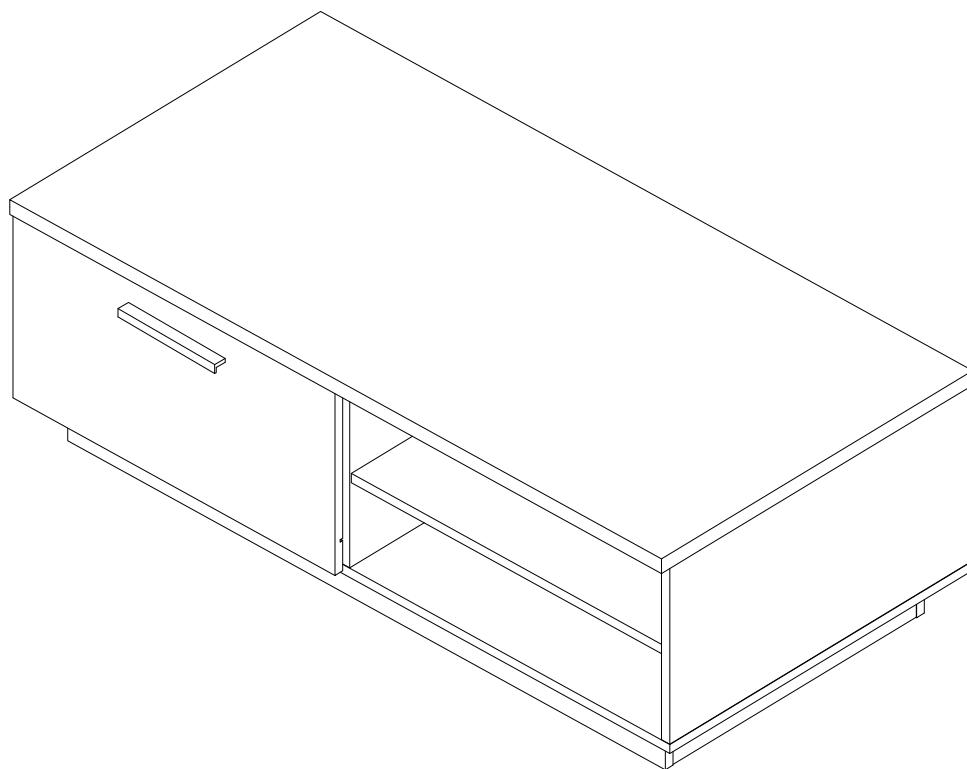

ASSEMBLY INSTRUCTIONS

MODEL : 97029 (COFFEE TABLE)
REV : 1

CAUTION :

- BEFORE ASSEMBLING, READ ALL THE INSTRUCTION.
- ENSURE ALL COMPONENTS ARE PLACE ONTO CARDBOARD AS PROTECTION.
- CLEAN SURFACE WITH A DRY OR DAMP SOFT CLOTH.
- DO NOT USE ABRASIVE CLEANERS, DETERGENT OR CHEMICAL.

TOOLS REQUIRED :

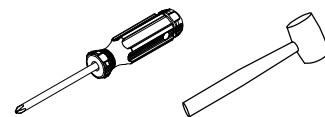



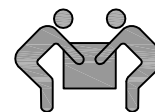





2 PERSON RECOMENDED

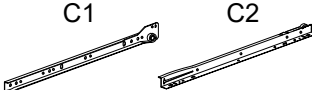

PART LIST

① x 1 	② x 1 	③ x 1 	④ x 1
⑤ x 1 	⑥ x 1 	⑦ x 1 	⑧ x 2
⑨ x 3 	⑩ x 2 	⑪ x 1 	⑫ x 1
⑬ x 1 	⑭ x 1 	⑮ x 1 	⑯ x 1

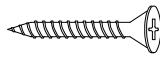

HARDWARE :

<p>Ⓐ x 1</p> 	<p>Ⓑ x 2</p>  <p>TRUSS HEAD M 4X25MM</p>	<p>Ⓒ x 1 SET</p>  <p>C1 C2</p>	<p>Ⓓ x 38</p> 
<p>Ⓔ x 38</p> 	<p>Ⓕ x 38</p> <p>8 X 30MM</p> 	<p>Ⓖ x 2</p> <p>6 X 30MM</p> 	<p>Ⓗ x 12</p>  <p>CB SCREW M3.5X12MM</p>
<p>Ⓘ x 4</p>  <p>CB SCREW M4 X 25MM</p>	<p>Ⓙ x 12</p>  <p>CB SCREW M4X32MM</p>		

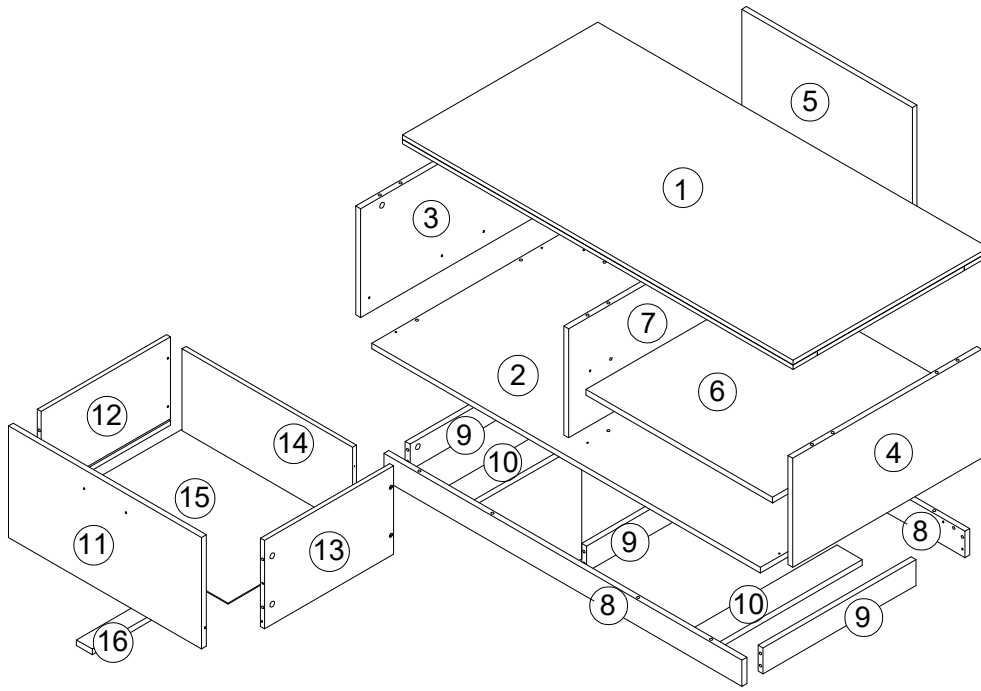
STEP 1



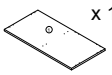
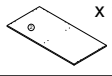
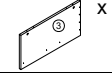
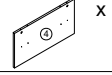
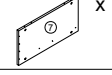
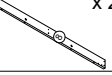

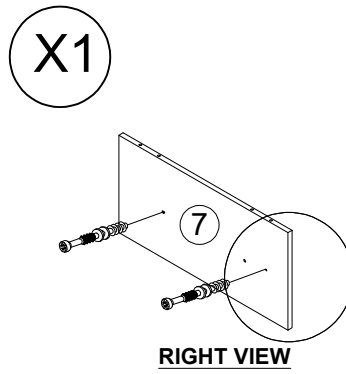
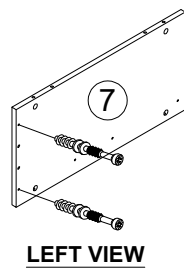
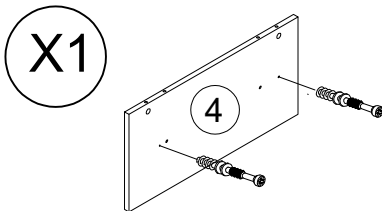
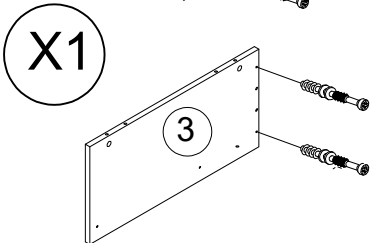
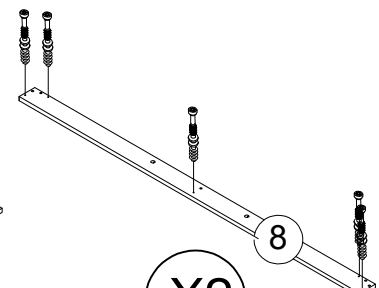
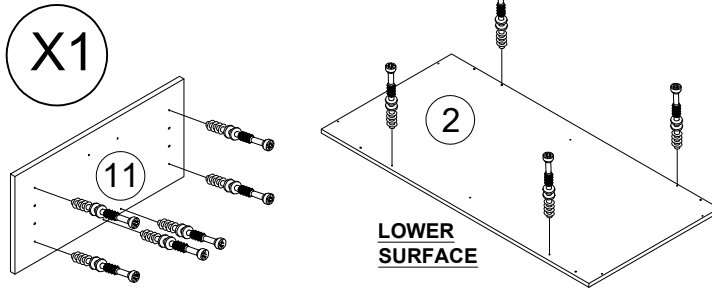
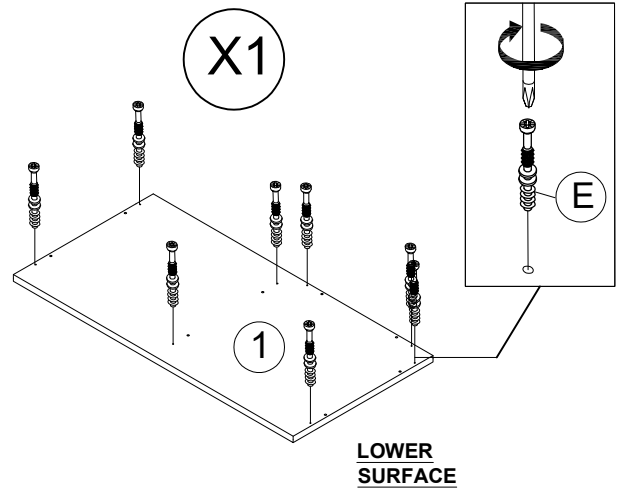
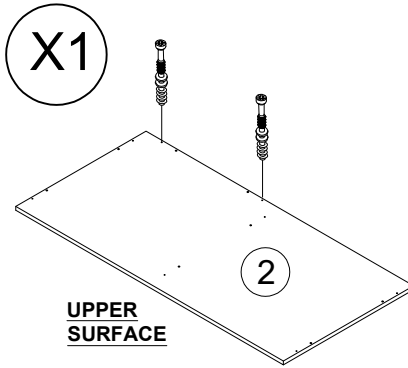

STEP 2

①	 x 1
②	 x 1
③	 x 1
④	 x 1
⑦	 x 1
⑧	 x 2
⑪	 x 1
E	 x 38





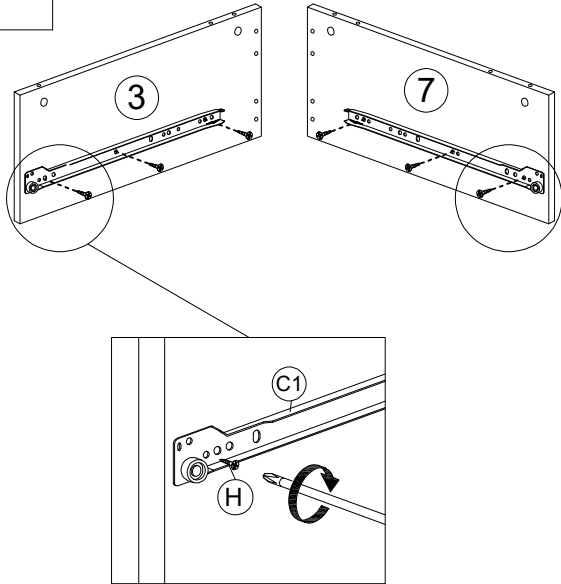

STEP 3

3		x 1
7		x 1
C1		x 1
H		x 6



STEP 5



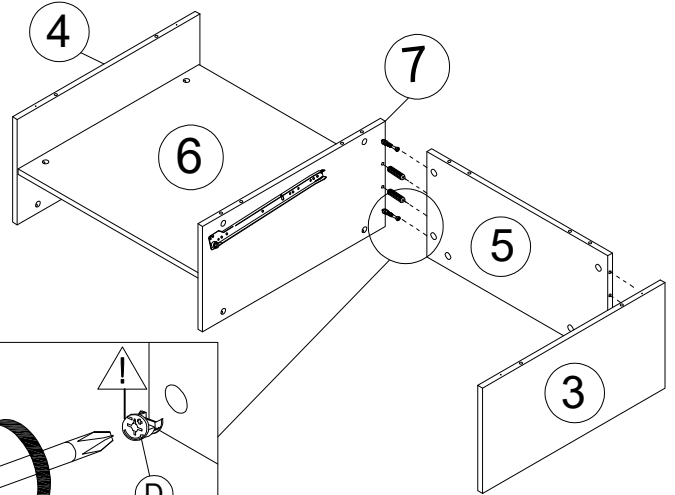

3		x 1	D		x 4
5		x 1	F		x 4

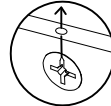

⚠ CAUTION



STEP 4



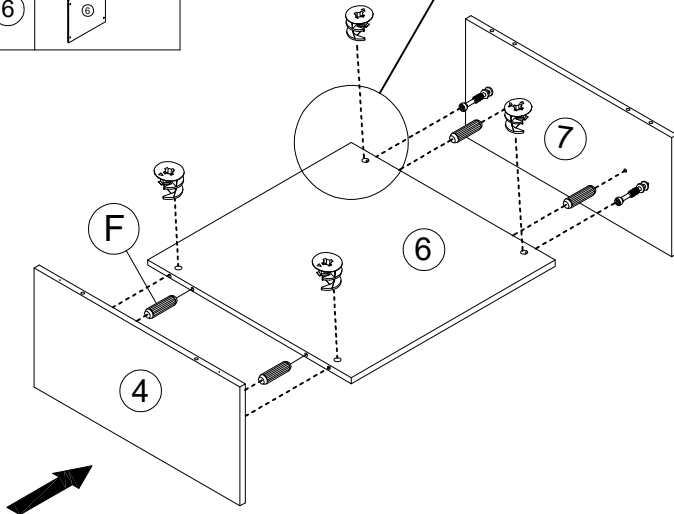
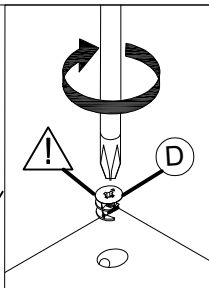

4		x 1	D		x 4
7		x 1	F		x 4
6		x 1			

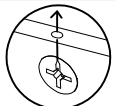

⚠ CAUTION



STEP 6

2		x 1
D		x 2
F		x 8
J		x 6

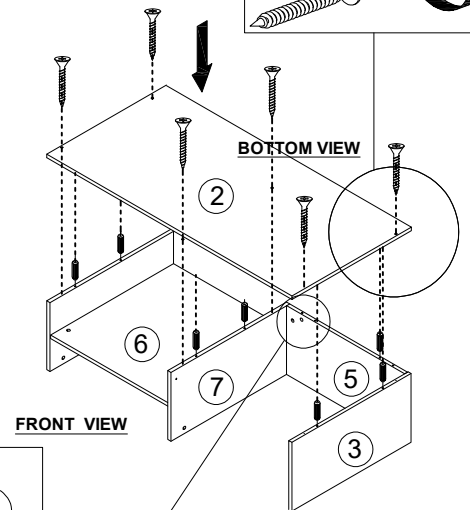
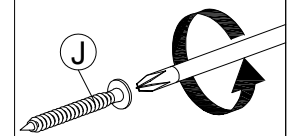

FRONT VIEW

BOTTOM VIEW

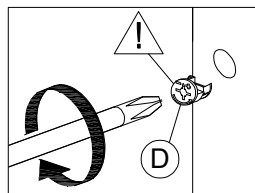



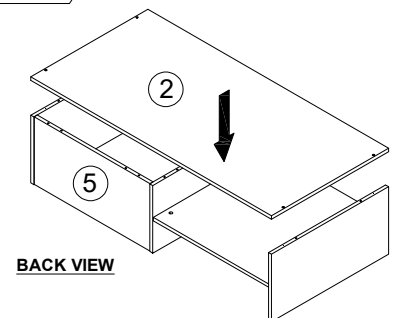
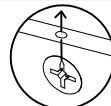

⚠ CAUTION

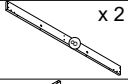

BACK VIEW

STEP 7

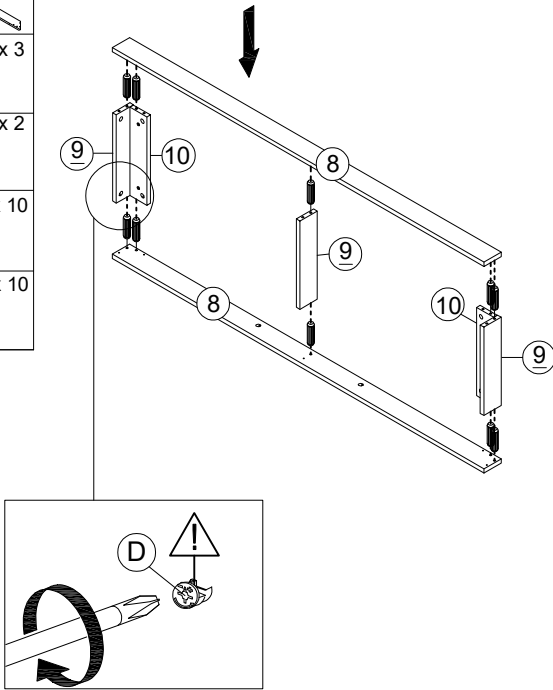

8		x 2
9		x 3
10		x 2
D		x 10
F		x 10

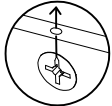

⚠ CAUTION



STEP 8

D		x 4
F		x 4
I		x 4

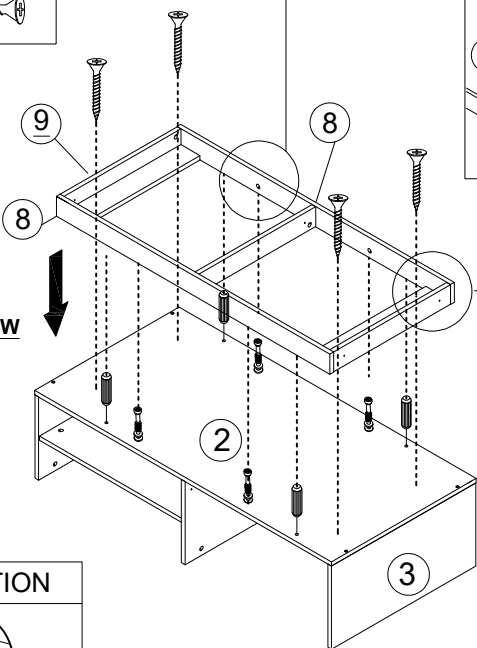
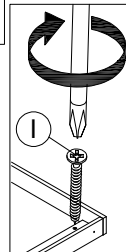
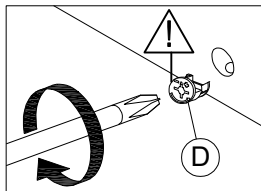

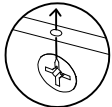

BOTTOM VIEW

⚠ CAUTION

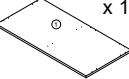

STEP 9

1		x 1
D		x 8
F		x 8

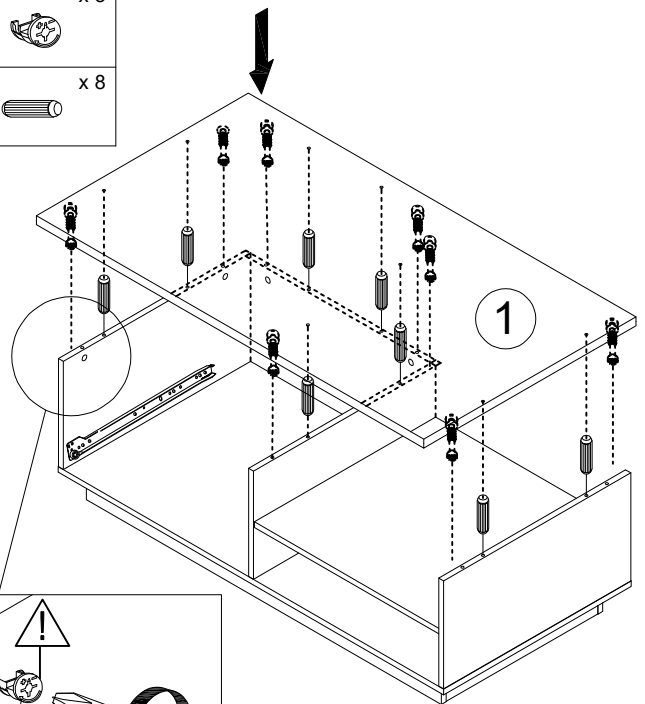



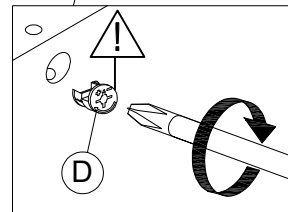

FRONT VIEW

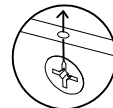

⚠ CAUTION





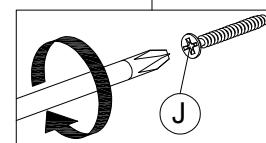
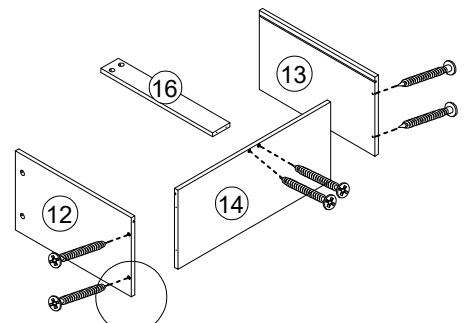

STEP 10

12		x 1
13		x 1
14		x 1
16		x 1
J		x 6



STEP 11

11		x 1
15		x 1
D		x 6
G		x 2

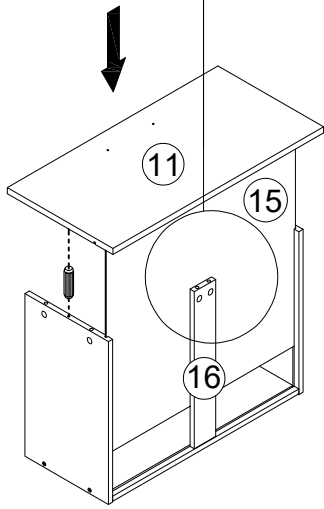
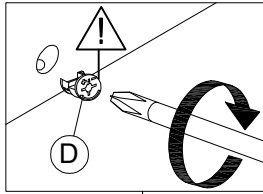

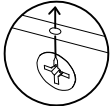

X1

CAUTION



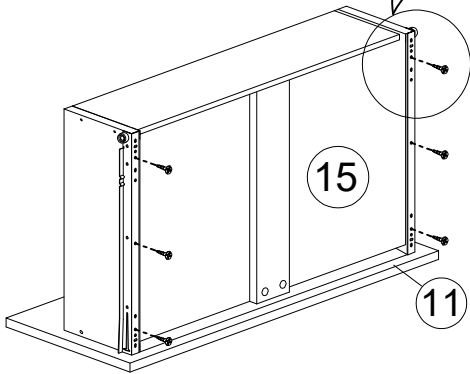
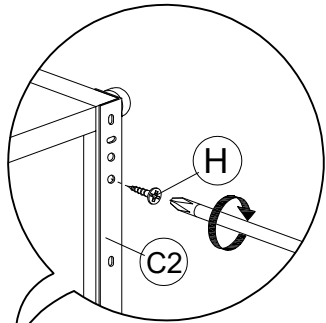

STEP 12

H		x 6
C2		x 6



BOTTOM VIEW

STEP 13

A		x 1
B		x 2

X1

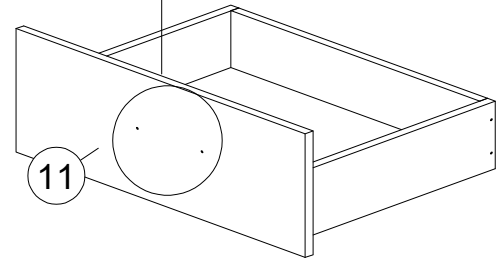
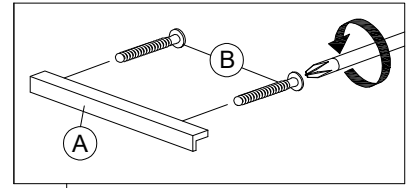

STEP 14

